Document filename: Technical Guidance for Templated CDA Domains v4.0 Approved			
Directorate / Programme	Information Standards Delivery	Project	Interoperability Specification Team
Document Reference		NPFIT-FNT-TO-DPM-0737	
Project Manager	Ken Lunn	Status	Approved
Owner	Richard Kavanagh	Version	4.0
Author	Kevin Sprague	Version issue date	23/05/2013

Technical Guidance for Implementation of Templated CDA Domains

Document Management

Revision History

Version	Date	Summary of Changes
1.0	07/08/2007	First Version for comment
	10/10/2007	<p>Fixed typos</p> <p>Added nullification diagram</p> <p>Updated allergy section</p> <p>Changed namespaces used for localisation to align with MIM</p> <p>Added medication guidance in appendix A</p> <p>Updated after internal review</p> <p>Updated after supplier comments</p> <p>Added additional and updated diagrams for further clarity</p>
1.1	03/12/2007	Updates to document control information
1.2	20/05/2008	<p>Removal of medication and allergy sections as this is now in separate documentation</p> <p>SCG Guidance on the Representation of Allergies and Adverse Reaction Information Using NHS Message Templates NPFIT-FNT-TO-SCG-0001.06/NPFIT-ELIBR-AREL-DST-0247.02</p> <p>Representation in Electronic Patient Records of Allergic Reactions, Adverse Reactions, and Intolerance of Pharmaceutical Products NPFIT-FNT-TO-SCG-0002.04/NPFIT-ELIBR-AREL-DST-0262.01</p> <ul style="list-style-type: none"> • Extended section on use of text section code • Updated section on replacement to clarify use of document id and parent document id, including updated diagrams • Updated referenced MIM version numbers to correct versions • Changed validation diagram and included text about the HSCIC workbench and NIC testing in validation section • Added section about use of version code for conformance testing • Updated section on text section to include details of new HSCI & DI use of coded text sections and ID attribute • Updated section on representing information using templates to include some new MIM 7.2.00 templates <p>To aid reviewers the following section are relevant to the above listed changes</p>

		<p>2.4.1.6.</p> <p>2.4.1.8.</p> <p>2.5.</p> <p>2.6.</p> <p>2.6.1.</p> <p>All of section 16</p> <p>All of section 20 from 20.4 onwards</p> <p>All of Section 22 from 22.2 onwards</p>
1.3	27/05/08	<p>Added section on template types</p> <p>Removed inconsistencies in the use of HSCIC and NPfIT</p> <p>Removed inconsistencies in use of CDA and HSCIC CDA</p> <p>To aid reviewers the following section are relevant to the above listed changes</p> <p>3.3.</p> <p>3.3.1.</p> <p>3.3.2.</p> <p>3.3.3.</p>
1.4	03/06/2008	<p>Updated after internal review</p> <p>Diagrams for replacement and nullification clarified (section 17)</p> <p>Reworded some of section 3.3</p>
1.5	09/01/2009	<p>Updated section 16 the include diagram for out of sequence updates</p>
2.0	24/04/2009	<p>Approved version</p>
2.1	16/12/2009	<p>Added information about requirement HSCI099REQ: New Document Recipient</p>
2.2	27/06/2011	<p>Added section on changes for universalisation</p>
3.0	18/08/2011	<p>Approved version</p>
4.0	23/05/2013	<p>Re-issued reformatted with HSCIC word template and replacing references to NHS CFH with HSCIC. Fixed incorrect section numbering and general formatting issues.</p>

Reviewers

This document must be reviewed by the following people:

Reviewer name	Title / Responsibility	Date	Version
Ravi Natarajan		18/08/2011	3.0

Interoperability Specification		23/05/2013	4.0
Team			
Tim Tett		18/08/2011	3.0

Approved by

This document must be approved by the following people:

Name	Signature	Title	Date	Version
Richard Kavanagh			18/08/2011	3.0
Richard Kavanagh			23/05/2013	4.0

Glossary of Terms

Term / Abbreviation	What it stands for
CDA	HL7 Clinical Document Architecture, Release 2.0
MIM	Message Implementation Manual
CRE	Care Record Element
x_domain	A HL7 term for a subset of a HL7 vocabulary code list
HSCIC Templated domain	A HSCIC MIM domain which has HL7 RMIMs which utilise the HSCIC HL7 templates
HSCIC localisation	Attributes added to a HL7 class or datatype with are only used for HSCIC implementations and can be safely ignored by non HSCIC systems.
Balloted or Ballot	HL7 Clinical Document Architecture, Release 2.0" (2006 Normative Edition),
SNOMED	(Systematized Nomenclature of Medicine) , is a systematically organised computer processable collection of medical terminology
CMET	(Common Message Element Type) , are intended to express a common, reusable pattern.
Template	A template is a RMIM which is used to constraint another model.
RMIM	(Refined message information model) , is an HL7 model derived from the HL7 RIM
RIM	(Reference information model)
Schematron	The Schematron is an XML structure validation language for making assertions about the presence or absence of patterns in trees. It is a simple and powerful structural schema language
mif	A HL7 model in an XML format
Participation	The involvement of a role in an act

actRelationship	A relationship between two acts
Class clone	A class that is a clone of another class, derived from another class
Act	Something happened or may happen
Entity	A person, animal, organisation or thing
Role	A responsibility or part played by an entity
Transform (XSLT)	a language for transforming XML
HSCI	Health and Social Care Integration
DI	Diagnostic Imaging
HL7	Health Level Seven
PSIS	Personal Spine Information Service
OID	Object identifier
UUID	Universally Unique Identifier
URL	Uniform Resource Locator
XML	Extensible Markup Language
HTML	Hyper Text Markup Language
PNG	Portable Network Graphics
TRUD	Terminology Reference Data Update Distribution Service
NPfIT	National Programme for Information Technology
HSCIC	Connecting for Health
CAF	Common Assessment Framework
ITK	Interoperability Toolkit
DMS	Domain Message Specification
Entity	A person, animal, organisation or thing
Role	A responsibility or part played by an entity
Transform (XSLT)	a language for transforming XML
HSCI	Health and Social Care Integration
DI	Diagnostic Imaging
HL7	Health Level Seven
PSIS	Personal Spine Information Service
OID	Object identifier
UUID	Universally Unique Identifier
URL	Uniform Resource Locator

Document Control:

The controlled copy of this document is maintained in the HSCIC corporate network. Any copies of this document held outside of that area, in whatever format (e.g. paper, email attachment), are considered to have passed out of control and should be checked for currency and validity.

Contents

1	Introduction	10
1.1	Purpose of Document	10
1.2	Background of HSCIC Template Development	10
1.3	Overview of HSCIC CDA Implementation	10
2	Detailed View of NHS CDA Implementation	13
2.1	HSCIC Domain and Template RMIM Usage	13
2.2	The Difference between “On the wire” and “templated” Instances	14
2.3	Comparison of “templated” and “on the wire” Instances	15
2.4	Validation of HSCIC CDA Documents	17
2.5	HSCIC Templated CDA validation Diagram	25
2.6	Use of VersionCode for Conformance Testing of TMS Interactions	25
2.7	Conformance Testing of ITK Interactions	26
3	Template Description	27
3.1	Use of Templates in HSCIC CDA Domains	28
3.2	Attributes Used with the Template Mechanism	28
3.3	Template Types	30
3.4	Template Artefact id Format	35
4	HSCIC CDA Localisation	36
4.1	messageType	36
4.2	contentId	37
4.3	recipientRoleCode	37
5	TemplateConfig.xml	38
5.1	TemplateConfig.xml element definitions	38
6	Template Cross Reference	41
7	Template versioning	42
8	Datatype Constraining in Templates	47
9	Use of default with mandatory codes	48
10	Use of Required Participations and Relationships	49
11	Use of References in Documents (Actrefs)	50
11.1	Act Reference Grids	54

12	Use of displayName and originalText in HSCIC CDA Documents	56
13	Referencing Between Coded Entries and Text	57
13.1	Illustration of referencing	57
13.2	Graphical representation of referencing using single template	58
13.3	Graphical representation of referencing using multiple templates	59
14	Data type Specialisations for Coded Elements to Allow CDA URL	60
14.1	Examples of URL specialisation constraint on code within RMIMs	61
14.2	Concept Descriptor with CDA URL	61
14.3	Coded Value with CDA URL	62
14.4	Coded with Equivalents with CDA URL	62
14.5	CDA URL schema fragment	63
15	Encompassing Encounter	64
16	HSCIC CDA Update Semantics	66
16.1	Class Attributes Associated With Replacement	68
16.2	ClinicalDocument.id and ParentDocument.id	68
16.3	ClinicalDocument.setId and ParentDocument.setId	68
16.4	ClinicalDocument.versionNumber	69
16.5	Illustration of Replacement	70
17	Document Nullification	71
17.1	Illustration of Nullification	71
18	Use of confidentialityCode	73
18.1	confidentialityCode Level One validation	74
19	SNOMED CT subsets and templates	75
19.1	SNOMED CT Subsets within Templates	75
19.2	Example of subset representation with a vocabulary	76
19.3	Subset Conformance within Templates	76
20	Text Section Template	78
20.1	Specialised Text Sections	79
20.2	Representation of author inheritance within text sections	82
20.3	Representing new authors within nested text sections	82
20.4	Example of nested author representation	84
20.5	Text Sections with Codes	84

20.6	Use of text section code in Health and Social Care Integration	85
20.7	CAF Information set code usage	85
20.8	Use of Text Section Code in Diagnostic Imaging Domain	88
20.9	The Use of html ID in text sections	90
20.10	Illustration ID Usage and TextHeadingType referencing in HSCI	91
21	Use of CRE types	92
21.1	How CRE type classification is implemented	92
21.2	Illustration of CRE type indexing	93
21.3	“On the wire” XML example of CREType categorisation	94
22	Representing Information Using Templates	95
22.1	Representing Vaccinations and Immunisations Using the Treatment Template	95
22.2	CarePlan and CarePlan Component Templates	97
22.3	Abstract Illustration of CarePlan and CarePlan Component	99
22.4	Assessment and Assessment Event Templates	99
22.5	Representing Assessments With or Without Scales	100
22.6	Examples of Representing Assessments	101
23	HSCI099REQ: New Document Recipient	107
23.1	How the Code (flag) is carried	107
23.2	Rules for Text Format	107
23.3	CDA Attributes / Artifacts Used to Meet Requirements	108
23.4	XML example	108
23.5	Rendered example	109
23.6	Illustration of process	110
24	Discounted Options During Template Development	111
24.1	Actrefs and Dummy templates	111
25	Universal Templates	111
25.1	Background	111
25.2	Approach to Universalisation	111
25.3	Use of Local Identifiers	112
25.4	Comparison of the Two Generic Models	112
25.5	Attachment Template	117
25.6	NonXMLBody	117
25.7	Coded Entries Using Alternative Coding to SNOMED CT	118
25.8	Universal Profiles Conformance Testing for ITK	118

1 Introduction

1.1 Purpose of Document

This document gives detailed technical information required to implement a HSCIC CDA templated domain. This document only forms part of the documentation required to implement a HSCIC CDA domain and should be used in conjunction with the message specification and the domain baseline document set. The reader is assumed to have some prior knowledge of the HSCIC message specifications and HL7.

Note: - Where an HL7 RMIM / model or any other message artefact is shown this may not be the latest version of that artefact and the relevant version of the message specification should be consulted for the actual artefact version to implement.

Due to the large amount / complexity of diagrams contained within this document it is recommended that MS Word web layout be used when reading a word version this document.

1.2 Background of HSCIC Template Development

The template mechanism used with the HSCIC templated CDA implementation is based on the modular approach first used in GP Summary (MIM 4.2), which was to tightened up the rules and dependences around CRE types , CMETs and SNOMED CT Subsets to provide a better, more consistent modelling approach that was easier to implement.

The templates used in the HSCIC CDA implementation take the place of the CMETs used in GP Summary and although the approach differs, somewhat the aim is still the same.

Using templates allows for greater extensibility and consistency of the messages / documents than CMETs allowed.

A library of templates will be maintained by HSCIC to meet new requirements and will be published in message specifications.

The same templating mechanism is used in both CDA and non-CDA based domains (that utilise the HSCIC templates) and therefore this guidance document applies equally to template usage in both styles of interaction.

1.3 Overview of HSCIC CDA Implementation

Most, if not all current CDA implementations outside of HSCIC use the CDA RMIM and some form of documentation to specify the constraints. Most of these implementations use tools such as Schematron to enforce the documented constraints.

Very few, if any implementations use HL7 model based templates mainly due to the fact that templates and the templating mechanism is only loosely defined in the HL7 Ballot. HSCIC pre-adopted model based templates after consultation with HL7 and applied them to its CDA implementation.

The HSCIC implementation started with the balloted CDA RMIM and constrained it to an NPfIT CDA RMIM which was used as the starting point when developing a domain for a PSIS/TMS conformant CDA document (referred to in this document as TMS interactions). Newer message specifications using universal profiles and ITK have a different constrained

model the NHS CDA RMIM. These universal conformant CDA documents are referred to as ITK interactions.

Important note :- the section on universalisation towards the end of the document details the difference between spine (PSIS/TMS interactions) and universal profiles (ITK interactions) and this section **MUST** be read if implementing any post MIM 7.2.02 specifications which are now known as Domain Message Specifications (DMS) and can be implemented using ITK.

The schema produced from either the NPfIT CDA RMIM or the NHS CDA RMIM model is used to validate “on the wire” instances and it is one of these two schemas, which is published in the message specifications as domain interaction schemas.

Domain RMIMs are produced using templates to further constrain the NPfIT CDA RMIM or the NHS CDA RMIM as required by the relevant business requirements.

Artefact IDs may have the realm identifier of “UK” or “GB” and therefore any examples that use UK are equally relevant.

*** Important note ***:- Vendors must send documents “on the wire” which directly validate against the NPfIT CDA RMIM or NHS CDA RMIM schema and not the tightened domain RMIM schema. See the section on Validation of HSCIC CDA Documents for full details on how documents should be validated.

1.4 Document Structure

All HSCIC CDA documents have a basic structure to provide a consistent format to the documents for ease of development, processing and in some cases support for PSIS.

The abstract model below details the basic structure and the following points should be noted:-

- This model shows a high level basic structure only
- The exact structure will vary dependent on the domain
- Class names are for illustration only
- Templates are not shown

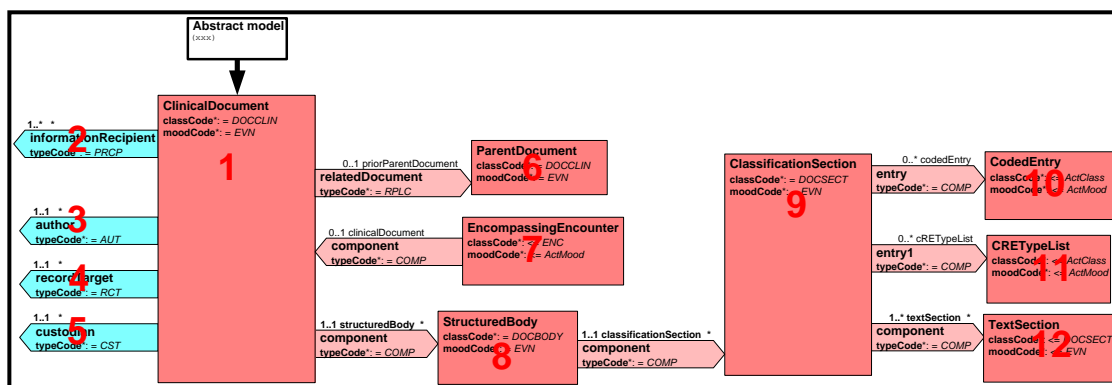

The table below indicates the rules that **MUST** be followed when designing domain documents. Each class has been detailed with its usage. Classes not

shown here can be present in domain models, these classes however have no generic rules.

Key

M=Must be present in Domain Model

P=Must be present in Domain Model but may be Optional

N=Need not be present in Domain Model, may be Mandatory or Optional

PO= Usage only applies to PSIS no usage rules for other implementations such as ITK

No	Usage	Class	Notes
1	M	ClinicalDocument	This class is referred to as header, used to hold document level information
2	M(PO)	infomationRecipient	Used to hold details of a recipient of a document. This may be a person, organisation or system
3	M(PO)	Author	Used to hold details of the author of the document, including the organisation the author is associated with. This may be a person, organisation or system
4	M	recordTarget	This is always the patient record
5	M	Custodian	This is the organisation legally responsible for the document
6	P	ParentDocument	Holds details of the previous version of the document. Used for updates by replacement
7	N	EncompassingEncounter	Details the overall encounter that is being documented
8	M(PO)	StructuredBody	Used for CDA structure only
9	M(PO)	ClassificationSection	This is a dummy section used with the templates to provide a simplified and consistent structure of sections
10	P(PO)	CodedEntry	<p>Since currently only medications and allergies are required to be coded, some documents may contain no coded entries.</p> <p>Additionally, for those domains where medication and allergy information may be carried, the coding requirement is that systems able to produce relevant SNOMED CT codes</p>

			<p>must do so. Systems that are incapable of producing SNOMED CT codes for medications and allergies may create CDA documents that carry medication and allergy information as text only.</p> <p>For these reasons, the domain RMIMs all carry coded entries as Optional</p>
11	P(PO)	CRETypeList	<p>Currently all CDA domains are modelled to allow classification by CRE type. Currently only medication and allergies are mandated therefore this class is marked as optional in the domain RMIMs.</p>
12	M(PO)	TextSections	<p>Used to carry the CDA marked up text to be rendered. All domain must have text sections present</p>

2 Detailed View of NHS CDA Implementation

2.1 HSCIC Domain and Template RMIM Usage

In order to conform to the CDA standard all CDA document instances MUST validate against the Balloted CDA Schema (POCD_MT000040.xsd) after filtering (removing) localisation. This Schema is provided by HL7 and is generated from the CDA Balloted RMIM. It has a generic structure and uses very generic class names such as Observation, Procedure, SubstanceAdministration and so forth.

When developing templates or domain models this causes some issues. For example, the HSCIC Blood Pressure template uses 3 observation classes called 'Blood Pressure', 'Systolic' and 'Diastolic'. These class names cannot be used directly with the CDA schema as it only allows the generic class name 'observation'. Building this template with 3 classes called observation would in theory validate against the schemas but is not a valid RMIM model as Act classes must be uniquely named within a model. These classes could be named as Observation, Observation1 and Observation2, which would result in a valid RMIM model, but this is not very helpful to a human reader and still fails validation against the Balloted CDA schema.

The Approach taken by HSCIC is to use meaningful, human readable class names in all the templates and domain RMIM models. The schemas generated from these RMIMS therefore contain illegal base CDA class names and can only be used to validate 'on the wire' document instances after transformation to a localised form. The implication of this being that the tighter schemas can only be utilised for conformance testing of documents and not at runtime unless the transform is applied.

A further explanation of these two formats is documented later in this section.

2.2 The Difference between “On the wire” and “templated” Instances

Throughout this document there are many references to “on the wire” format and “templated” format when referring to xml instances and examples. This concept is the key to understanding the deployment model for HSCIC implementations and is therefore explained in detail within this section.

The “on the wire” format is the actual xml instance with the balloted CDA class names that will flow on the wire and may be stored on PSIS and/or other systems.

For PSIS/TMS interactions

This format validates against the POCD_MT000001UKnn.xsd (nn will be relevant version number of the schema) and validates against the balloted CDA schema.

For ITK Interactions

This format validates against the POCD_MT000002UKnn.xsd (nn will be relevant version number of the schema) and validates against the balloted CDA schema.

The “templated” format is the “on the wire format” transformed to use template class names that will validate against the domain schema and any referenced template schema. This form is not expected to be created or consumed by systems within the HSCIC project.

The “templated” form will be generated by applying a transform during conformance testing and during any quality assurance tests carried out by HSCIC.

Both formats of examples are provided in the message specification. In a MIM the “on the wire” format is linked from the domain implementation manual as is normal practice and the “templated” format examples are provided in the Templated Examples directory but not hyperlinked.

In a DMS both the “on the wire” format and the “templated” formats are linked from the message specification and rendered examples are also included.

*** Important note *** :- With non CDA domains the two formats are identical as non CDA instances use the class names as they appear in the templates and no transformation is required.

“on the wire” CDA Representation (note this is NOT a valid HL7 RMIM)

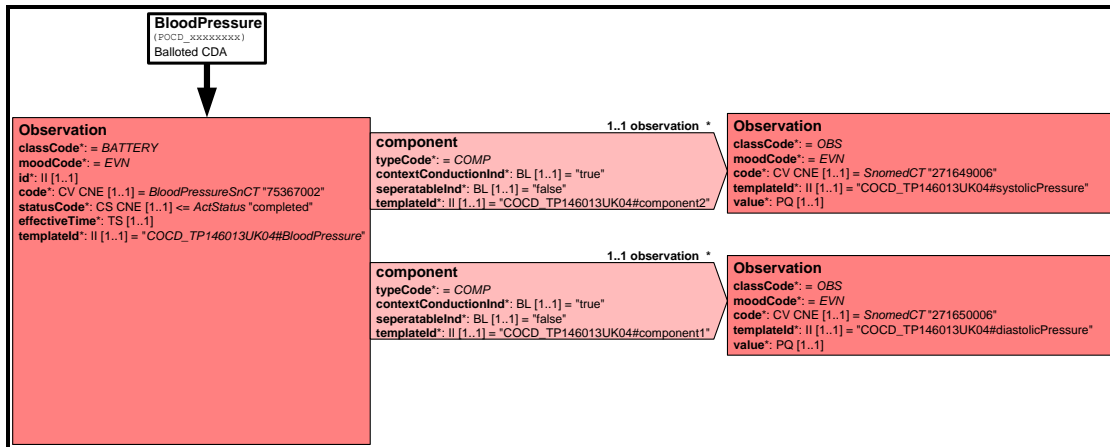

“Template” Representation (note this is a valid HL7 RMIM)

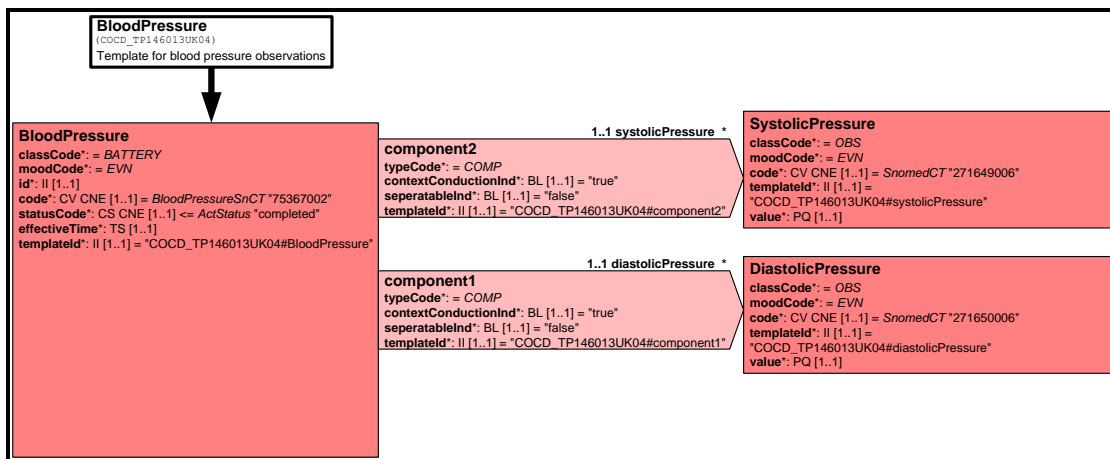

2.3 Comparison of “templated” and “on the wire” Instances

In the message specifications example xml instances are created in a “templated” format and then transformed to the “on the wire” HSCIC CDA format.

2.3.1 “Templated” format

```
<entry typeCode="COMP" contextConductionInd="true">
  <npfict:contentId root="2.16.840.1.113883.2.1.3.2.4.18.16" extension="COCD_TP146013UK04#BloodPressure"/>
  <COCD_TP146013UK04.BloodPressure classCode="BATTERY" moodCode="EVN">
    <code codeSystem="2.16.840.1.113883.2.1.3.2.4.15" code="75367002" displayName="Blood pressure"/>
    </code>
    <effectiveTime value="200605051410"/>
    <id root="26B51E02-B658-4489-88CE-D65CA2E35555"/>
    <statusCode code="completed"/>
    <templateId root="2.16.840.1.113883.2.1.3.2.4.18.2" extension="COCD_TP146013UK04#BloodPressure"/>
    <component1 typeCode="COMP" contextConductionInd="true">
      <seperatableInd value="false"/>
      <templateId root="2.16.840.1.113883.2.1.3.2.4.18.2" extension="COCD_TP146013UK04#component1"/>
      <diastolicPressure classCode="OBS" moodCode="EVN">
        <code codeSystem="2.16.840.1.113883.2.1.3.2.4.15" code="271650006" displayName="Diastolic blood pressure"/>
        <templateId root="2.16.840.1.113883.2.1.3.2.4.18.2" extension="COCD_TP146013UK04#diastolicPressure"/>
        <value value="85" unit="mm[Hg]"/>
      </diastolicPressure>
    </component1>
    <component2 typeCode="COMP" contextConductionInd="true">
      <seperatableInd value="false"/>
      <templateId root="2.16.840.1.113883.2.1.3.2.4.18.2" extension="COCD_TP146013UK04#component2"/>
      <systolicPressure classCode="OBS" moodCode="EVN">
        <code codeSystem="2.16.840.1.113883.2.1.3.2.4.15" code="271649006" displayName="Systolic blood pressure"/>
        <templateId root="2.16.840.1.113883.2.1.3.2.4.18.2" extension="COCD_TP146013UK04#systolicPressure"/>
        <value value="140" unit="mm[Hg]"/>
      </systolicPressure>
    </component2>
  </COCD_TP146013UK04.BloodPressure>
</entry>
```

2.3.2 “on the wire” format

Note: - Sort order in CDA schema and HSCIC domain / template (profile) schema is different, therefore order in xml instances also differ.

```
<entry typeCode="COMP" contextConductionInd="true">
  <npfict:contentId root="2.16.840.1.113883.2.1.3.2.4.18.16" extension="COCD_TP146013UK04#BloodPressure"/>
  1-><organizer classCode="BATTERY" moodCode="EVN">
    <templateId root="2.16.840.1.113883.2.1.3.2.4.18.2" extension="COCD_TP146013UK04#BloodPressure"/>
    <id root="26B51E02-B658-4489-88CE-D65CA2E35555"/>
    <code codeSystem="2.16.840.1.113883.2.1.3.2.4.15" code="75367002" displayName="Blood pressure"/>
    </code>
    <statusCode code="completed"/>
    <effectiveTime value="200605051410"/>
    2-><component typeCode="COMP" contextConductionInd="true">
      <templateId root="2.16.840.1.113883.2.1.3.2.4.18.2" extension="COCD_TP146013UK04#component1"/>
      <seperatableInd value="false"/>
      3-><observation classCode="OBS" moodCode="EVN">
        <templateId root="2.16.840.1.113883.2.1.3.2.4.18.2" extension="COCD_TP146013UK04#diastolicPressure"/>
        <code codeSystem="2.16.840.1.113883.2.1.3.2.4.15" code="271650006" displayName="Diastolic blood pressure"/>
        <value xsi:type="PQ" value="85" unit="mm[Hg]"/>
      </observation>
      4-></observation>
      5-></component>
      6-><component typeCode="COMP" contextConductionInd="true">
        <templateId root="2.16.840.1.113883.2.1.3.2.4.18.2" extension="COCD_TP146013UK04#component2"/>
        <seperatableInd value="false"/>
        7-><observation classCode="OBS" moodCode="EVN">
          <templateId root="2.16.840.1.113883.2.1.3.2.4.18.2" extension="COCD_TP146013UK04#systolicPressure"/>
          <code codeSystem="2.16.840.1.113883.2.1.3.2.4.15" code="271649006" displayName="Systolic blood pressure"/>
          <value xsi:type="PQ" value="140" unit="mm[Hg]"/>
        </observation>
        8-></observation>
        9-></component>
        10-></component>
      </organizer>
    </entry>
```

Arrows highlight differences in elements due to class name and xsi:type differences. These differences are explained in further detail in the table below.

No	Templated	On the Wire HSCIC CDA
1	<COCD_TP146013UK04.BloodPressure>	<organizer>
2	<component1>	<component>
3	<diastolicPressure>	<observation>
4	</diastolicPressure>	</observation>
5	</component1>	</component>

6	<component2>	<component>
7	<systolicPressure>	<observation>
8	xsi:type is not required as constrained to "PQ" in template schema	xsi:type="PQ" required as value is unconstrained in balloted CDA schema
9	</systolicPressure>	</observation>
10	</component2>	</component>
11	</COCD_TP146013UK04.BloodPressure>	</organizer>

2.4 Validation of HSCIC CDA Documents

'The message specifications utilise the current HL7 guidance on template usage within a CDA document. HSCIC have also utilised the localisation rules to further constrain the Balloted CDA model for implementation in a NHS context.'

The NPfIT CDA RMIM and its schema or the NHS CDA RMIM and its schema can both be used as a direct replacement model for the normative CDA for HSCIC use. Features of CDA that have been removed when creating the NPfIT CDA RMIM are not anticipated to be used in the NPfIT programme. The NPfIT version enforces certain NPfIT specific rules that are common to all messaging domains implemented for PSIS/TMS. The NHS CDA RMIM does not remove any features of CDA but any profile based on the NHS CDA RMIM could and probably will.

There are several stages to conformance for a HSCIC CDA Document.(PSIS/TMS or universal profile)

For PSIS/TMS profiles (interactions)

- All HSCIC CDA documents must conform to the normative standard HL7 CDA model, and its schema.
- Secondly all HSCIC CDA documents will conform to the NPfIT CDA RMIM. This is a valid constraint of the normative HL7 standard and it must be possible to schema validate a HSCIC CDA document against the XML schema associated with this RMIM. (Both of these models and all actual HSCIC CDA document instances use the standard CDA XML element names.)
- Each HSCIC CDA document must conform to the set of templates that are defined for use with its domain, as detailed in the relevant MIM. Each template exists as an RMIM in its own right, and details additional constraints that apply to a certain part of a HSCIC CDA document.

For ITK profiles (interactions)

- All HSCIC CDA documents must conform to the normative standard HL7 CDA model, and its schema.
- Secondly all HSCIC CDA documents will conform to the NHS CDA RMIM. This is a valid constraint of the normative HL7 standard and it must be possible to schema validate a HSCIC CDA document against the XML schema associated with this RMIM. (Both of these models and all actual HSCIC CDA document instances use the standard CDA XML element names.)
- Each HSCIC CDA document must conform to the set of templates that are defined for use with its domain, as detailed in the relevant DMS. Each template exists as an RMIM in its own right, and details additional constraints that apply to a certain part of a HSCIC CDA document.

For practical and technical reasons templates may (and usually do) include class names that differ from the CDA class names. It is not possible therefore to use ordinary schema validation to verify the template constraints. Instead a two pass, transform then validate method can be used. The following process describes the steps to perform a two-stage conformance test of a particular message instance:

For PSIS/TMS profiles (interactions)

- LEVEL 1 - Validation of the HSCIC CDA document instance using the NPfIT CDA RMIM schema (POCD_MT000001UK04.xsd) and domain schematron (where schematron exists for domain)
- Transform the message instance, replacing the generic class names with template class names
- LEVEL 2 - Validation of the HSCIC CDA document instance, using specific domain and template schemas as contained in the relevant message specification

For ITK profiles (interactions)

- LEVEL 1 - Validation of the HSCIC CDA document instance using the NHS CDA RMIM schema (POCD_MT000002UK01) and domain schematron (where schematron exists for domain)
- Transform the message instance, replacing the generic class names with template class names
- LEVEL 2 Validation of the HSCIC CDA document instance, using specific domain and template schemas as contained in the relevant message specification

Note level two validation is done using the same set of schemas regardless of which interaction type is used. This is because the domain profile is a single profile, which supports both interactions types. The level one validation will trap validation errors, which are particular to the interaction type being tested.

The artefacts used within the HSCIC CDA implementation are detailed within the [Artefacts for HSCIC CDA Document Validation](#) section including any requirements regarding usage.

All HSCIC CDA documents must validate at both levels but the level 2 validation can be carried out using any method that gives the same validation. This document does not suggest or document any alternative method.

Important note * - HSCIC does not mandate the use of a two-pass transform then validate approach. However if any other approach is used the validation must give the same result. Therefore, any instance on the wire must still validate using the two-pass method. The two-pass validation will be used during the accreditation process performed by the National Integration Centre and Assurance (NICA) team during conformance testing.

2.4.1 Artefacts for HSCIC CDA Document Validation

For PSIS/TMS interactions

All HSCIC CDA documents (“on the wire” format)

- MUST validate against the [POCD_MT000001UKnn.xsd](#)
- MUST validate using the relevant *domain Schematron* where applicable
- MUST validate using the [Generic CDA Document Schematron.xml](#)
- MUST be capable of being rendered using the [CDA NPfIT Document Renderer.xsl](#)
- MUST be capable of being transformed using [CDALikeToTrueCDA.xsl](#) and [TrueCDAToCDALike.xsl](#) without error.
- Once transformed using [TrueCDAToCDALike.xsl](#) MUST validate against the domain schema and any included *template schema*

- Once transformed using [TrueCDAToCDALike.xsl](#) MUST validate against [HSCIC CDA Document Schematron.xml](#)

These artefacts are contained in the MIM in the Generic CDA Documentation section and are detailed in the following sections within this document.

For ITK interactions

All HSCIC CDA documents (“on the wire” format)

- MUST validate against the [POCD_MT000002UKnn.xsd](#)
- MUST validate using the relevant *domain Schematron* where applicable
- MUST validate using the [Generic CDA Document Schematron.xml](#)
- MUST be capable of being rendered using the [CDA NPfIT Document Renderer.xsl](#)
- MUST be capable of being transformed using [CDALikeToTrueCDA.xsl](#) and [TrueCDAToCDALike.xsl](#) without error.
- Once transformed using [TrueCDAToCDALike.xsl](#) MUST validate against the domain schema and any included *template schema*
- Once transformed using [TrueCDAToCDALike.xsl](#) MUST validate against [HSCIC CDA Document Schematron.xml](#)

These artefacts are contained in the DMS in the Generic CDA section and are detailed in the following sections within this document.

Important note * - These artefacts have now been incorporated in the HSCIC Workbench. HSCIC CDA document examples in the MIM have been validated using the HSCIC workbench and associated artefacts. The components used within the workbench test for document structure conformance at a technical level and the same components are used in NICA testing. Although this is the same approach used by the NICA during conformance testing, the NICA testing may involve further business level validation. The HSCIC work bench is available for suppliers to use (currently downloadable from HSCIC extranet or contact [mailto:interoperabilityteam@hscic.gov.uk?subject=Validation tooling](mailto:interoperabilityteam@hscic.gov.uk?subject=Validation%20tooling)). Further conformance testing tools should be available from the NIC later.

A diagram showing the use these artefacts and the HSCIC Workbench is contained within the HSCIC [Templated CDA validation Diagram section](#)

2.4.1.1 NPfIT CDA RMIM (POCD_RM000001UKnn)

Usage - Informative

This is the NPfIT CDA RMIM (HL7 model) which is a valid constraint of the CDA RMIM (HL7 model) (normative edition R2-2006). This is the RMIM that all HSCIC CDA domain models and templates are compliant with when used over TMS.

It acts as a constraint on normative CDA by

- Removing unnecessary features
- Being more specific in some areas
- Providing a pattern from which individual CDA profiles can further be refined, through template use
- Allowing creation of an XML schema that can be used as a first pass validation for any HSCIC CDA document which used TMS interactions
 - This is the schema supplied to TMS and is the level to which systems should be built against for future proofing. The schema is published in the DMS and also in MIMs.
 - This is the schema referenced in the interaction schemas and the interaction schemas are linked to in the schema in the DMS using this icon 

2.4.1.2 NHS CDA RMIM (POCD_RM000002UKnn)

Usage - Informative

This is the NHS CDA RMIM (HL7 model) which copy of the CDA RMIM (HL7 model) (normative edition R2-2006). This is the RMIM that all HSCIC CDA domain models and templates are compliant with when using ITK.

- It provides a pattern from which individual CDA profiles can further be refined, through template use
- Allowing creation of an XML schema that can be used as a first pass validation for any HSCIC CDA document with uses ITK interactions.
 - This is the schema supplied in the DMS and is the level to which systems should be built against for future proofing.
 - There are no interaction schemas for ITK as ITK does not use the concept of interactions schema.

2.4.1.1 HSCIC Style Sheet(CDA_NPfit_Document_Renderer.xsl)

Usage - Optional

An HSCIC version of the balloted CDA style sheet to provide an indication of how the “on the wire” format HSCIC CDA documents may be rendered. This is published in the message specifications and is used to render the rendered examples included in the message specifications.

*** Important note *** to vendors this artefact is not intended to be incorporated into live systems and is not supported by HSCIC and is supplied without prejudice.

2.4.1.2 Generic Schematron

These schematron validate contentId and templateId to help ensure the templating mechanism has been applied correctly.

Generic_CDA_Document_Schematron.xml

Usage - All documents must validate against the Generic schematron.

This schematron is run on the “on the wire” HSCIC CDA xml instance to validate that contentId references the correct templateId.

HSCIC_CDA_Document_Schematron.xml

Usage - All documents that have been transformed may be validated using this schematron.

This schematron is run on the “templated” HSCIC CDA xml instance to validate that contentId references the correct template.

2.4.1.3 HSCIC Transforms

Generic CDA to Templated Document transform - TrueCDAToCDALike_v2.xsl

Usage - Informative

This transform can be used to transform the document instances from “on the wire” format (balloted CDA classNames) to “templated” format (specific templated classNames) to allow further validation.

*** Important note *** to vendors this artefact is not intended to be incorporated into live systems and is not supported by HSCIC and is supplied without prejudice.

Templated Document to Generic CDA transform - CDALikeToTrueCDA_v2.xsl

Usage – Informative

This transform can be used to transform the document instances from “templated” format (templated HSCIC CDA classNames) to “on the wire” format (balloted CDA classNames). This allows “round trip” validation and easy creation of xml examples within the message specifications.

These transforms use templateId and contentId for the above purposes. The prime uses of these transforms are for instance example creation and system testing.

*** Important note *** to vendors this artefact is not intended to be incorporated into live systems and is not supported by HSCIC and is supplied without prejudice.

2.4.1.4 Domain Schemas

Usage - All documents must be capable of passing validation against the relevant domain schema.

These schemas are provided in the relevant domains and are used to validate transformed (“Templated” format) document instances. These schemas DO NOT use the balloted CDA schemas classNames and therefore require the instance to be transformed from “on the wire” format to “templated” format before schema validation can be carried out.

These schemas are linked to in the message specification using this icon 

2.4.1.5 Constraint Schemas

Usage - Dependant on conformance level of the system as defined by the HSCIC business requirements for the given domain.

These schemas are used (included) by the Domain Schemas and documents must validate against the schemas relevant to the systems conformance level as specified in the domain implementation guidance. These schemas only contain a list of includes for the relevant templates.

Illustration of constraint schema shown template schema includes

```
<xs:include schemaLocation=" ../Schemas/COCD_TP145008UK03.xsd"/>  
<xs:include schemaLocation=" ../Schemas/COCD_TP145014UK03.xsd"/>  
<xs:include schemaLocation=" ../Schemas/COCD_TP145025UK01.xsd"/>
```

Important Note *:- These constraint schemas have the same file names as the constraint shown on the RMIM diagrams. Versioning of these constraint schemas is NOT contained in the filename but is carried internally.

Illustration of versioning in constraint schema

```
<xs:annotation>
  <xs:appinfo>
    <constraint version="2.0"/>
  </xs:appinfo>
</xs:annotation>
```

As the filename of a constraint schema does not contain the version number, changes to the constraint schema version number do not affect the domain schema as the include remains unchanged. This is how the templating mechanism allows changes to templates to be applied without changes message type or interaction versions. For further clarification on versioning, please see the section on [profile schemas](#).

Illustration of constraint schema includes in domain schema

```
<xs:include schemaLocation=" ../TemplateSchemas/NPFIT-000014_Role.xsd"/>
<xs:include schemaLocation=" ../TemplateSchemas/NPFIT-000008_Role.xsd"/>
<xs:include schemaLocation=" ../TemplateSchemas/NPFIT-000007_Role.xsd"/>
<xs:include schemaLocation=" ../TemplateSchemas/NPFIT-000019_Role.xsd"/>
<xs:include schemaLocation=" ../TemplateSchemas/NPFIT-000040_Section.xsd"/>
<xs:include schemaLocation=" ../TemplateSchemas/NPFIT-000036_Section.xsd"/>
<xs:include schemaLocation=" ../TemplateSchemas/NPFIT-000032_Section.xsd"/>
<xs:include schemaLocation=" ../TemplateSchemas/NPFIT-000024_Role.xsd"/>
<xs:include schemaLocation=" ../TemplateSchemas/NPFIT-000016_Role.xsd"/>
<xs:include schemaLocation=" ../TemplateSchemas/NPFIT-000001_Act.xsd"/>
```

2.4.1.6 Template Schemas

Usage - Dependant on conformance level of the system as defined by the HSCIC business requirements for the given domain.

These schemas are used (included) by the Constraint Schemas. Documents must validate against the schemas relevant to the systems conformance level as specified in the domain implementation guidance. The schemas DO NOT use the balloted CDA schemas classNames and therefore require the instance to be transformed from “on the wire” format to “templated” format before schema validation can be carried out.

These schemas are linked to in the template implementation manual using this icon 

2.4.1.7 Profile Schemas

“Profile schemas” is the name given to the collection of schemas used for second level validation.

This collection consists of the following

- The domain schema
- The relevant constraint schemas (specified using includes in the domain schema)
- The relevant template schemas (specified using includes in the constraint schema)

Illustration of where the versioning is held within the profile schema collection

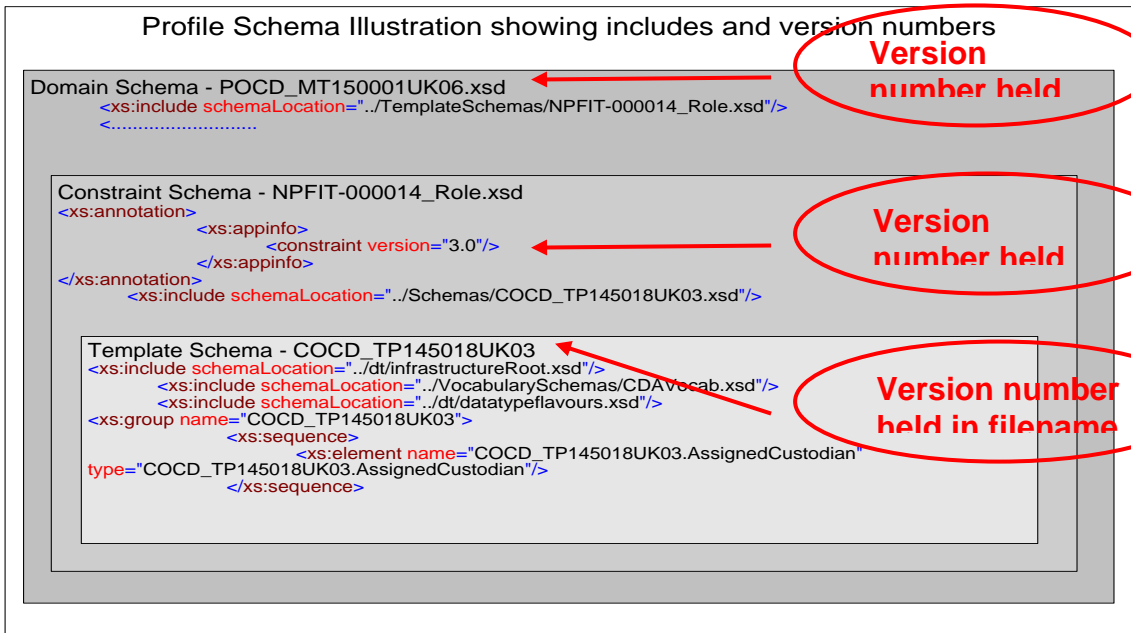

Illustration of versioning within the profile schema collection

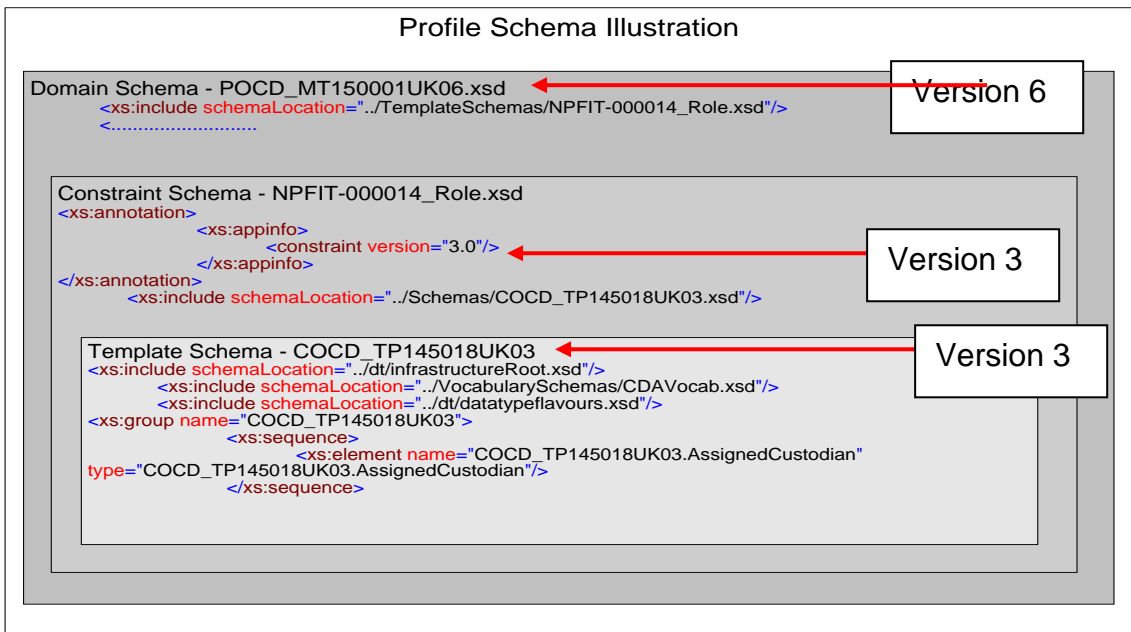
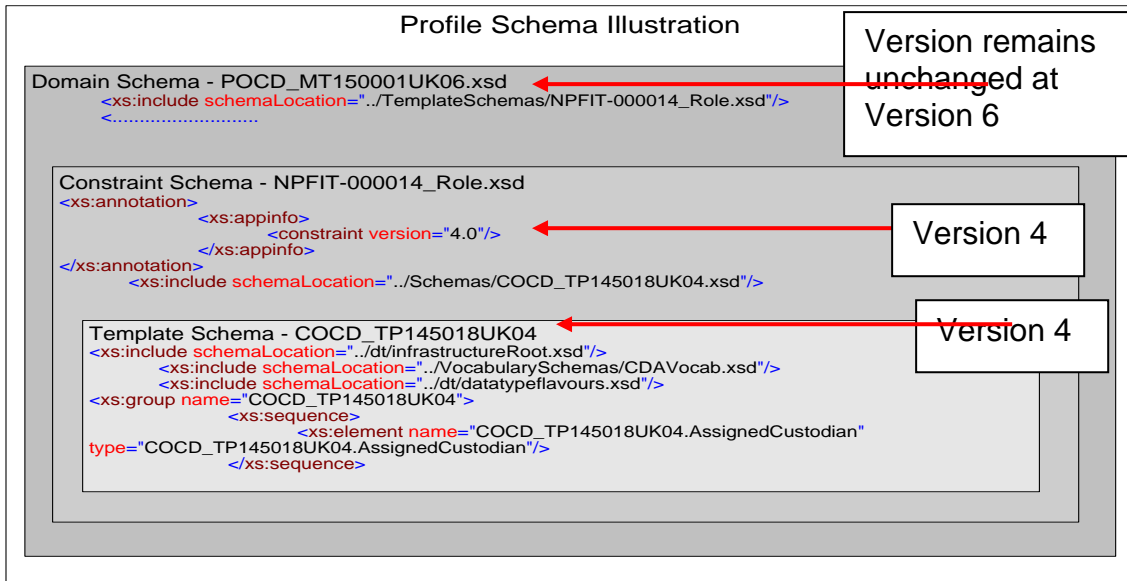
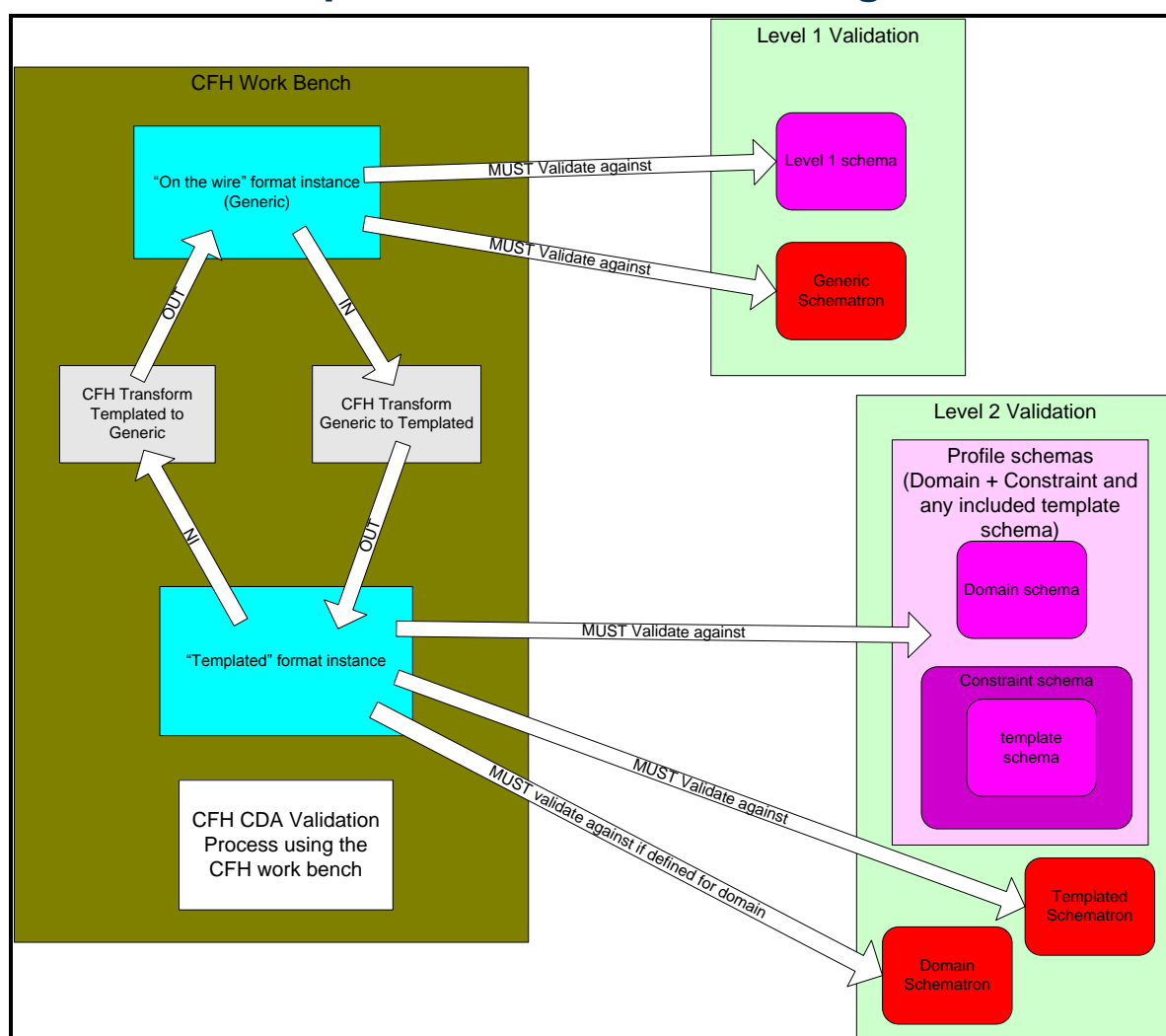

Illustration of up versioning within the profile schema collection when a template changes



2.5 HSCIC Templated CDA validation Diagram



***Important Note*:-** the level 1 schema in diagram above will differ dependant or whether it is a TMS interaction payload or a ITK interaction payload.

2.6 Use of VersionCode for Conformance Testing of TMS Interactions

During system testing, of TMS interactions the version of the message specification used as baseline for the message needs to be identified.

Why is this required?

The HSCIC CDA templating mechanism allows different constraints in the form of new templates or new versions of existing templates to be applied to a HSCIC CDA document without up-versioning the interaction or message type. During conformance testing, the version code from the HL7StandardVersionCode vocabulary carried in the send message payload (wrapper) is used to ascertain which version of the message specification the HSCIC CDA document has been built against and which conformance rules should be applied. It is therefore essential that all test instances contain the correct version code.

*** Important note to Vendors *:- Use of Version code documented here is for conformance testing only. Currently there are no requirements for version code to be mandated for use by live systems.**

Illustration of VersionCode Usage

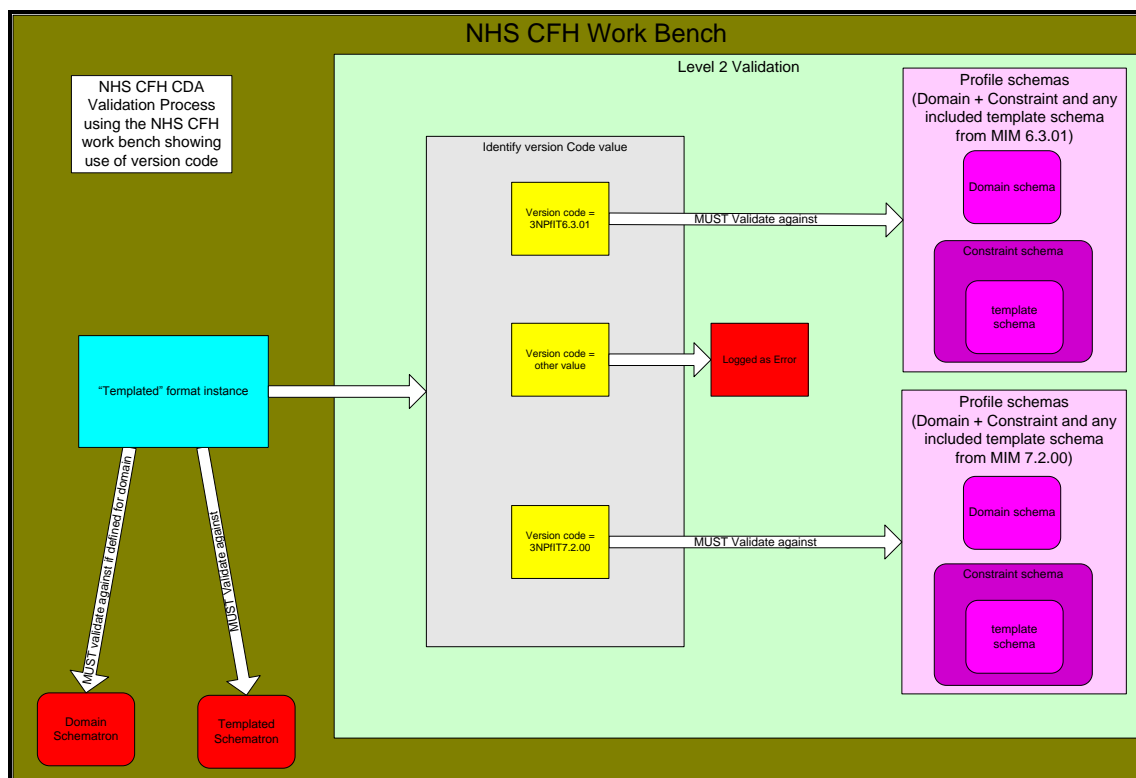

2.7 Conformance Testing of ITK Interactions

During system testing, of ITK interactions the version of the message specification is not used to identify what to use for the conformance profile. For ITK interactions the interaction ID will be up versioned whenever there is a change to a defined list of artefacts. This list of artefacts is defined in the ProfileId which is now available in the DMS under the reference navigation tab. This means that the same interaction can be used from any DMS and therefore the DMS identifier is not required. This is a different approach to what was previous done for MIMs and Spine releases, which can only be used now that the message specifications are domain specific.

3 Template Description

A brief description from the HSCIC perspective

A template is an RMIM model that may be used to constrain another RMIM model in some way.

In HL7 any model can be a template no matter which classes it uses. This is because all classes can use the attribute templateId to identify the template.

In the HSCIC implementation, all classes can be templates with the exception of entities.

The reason why the HSCIC implementation does not support entity templating is due to HSCIC's use of two attributes (instead of the normal one) in its templating mechanism i.e. the standard attribute [templateId](#) and the local attribute [contentId](#).

The local attribute contentId can be only present in the participation or actRelationship immediately prior to the template. Entities are not entered a participation or actRelationship but via a playing or scoping association and therefore the use of this attribute is not possible when templating entities. HSCIC has mandated the use of both attributes in its implementation and has accepted this causes a limitation

This limitation was deemed to have only minimal impact during the development of the templating mechanism and decision to use contentId.

The RMIM has the artefact id format of COCD_TPnnnnnn"UKorGB"nn to identify it as a template.

The model is saved to mif and html files in the message specification just like any other model

The directory / file structure in the MIM is similar format to CMETs (Domains\Templates\ etc)

Example template

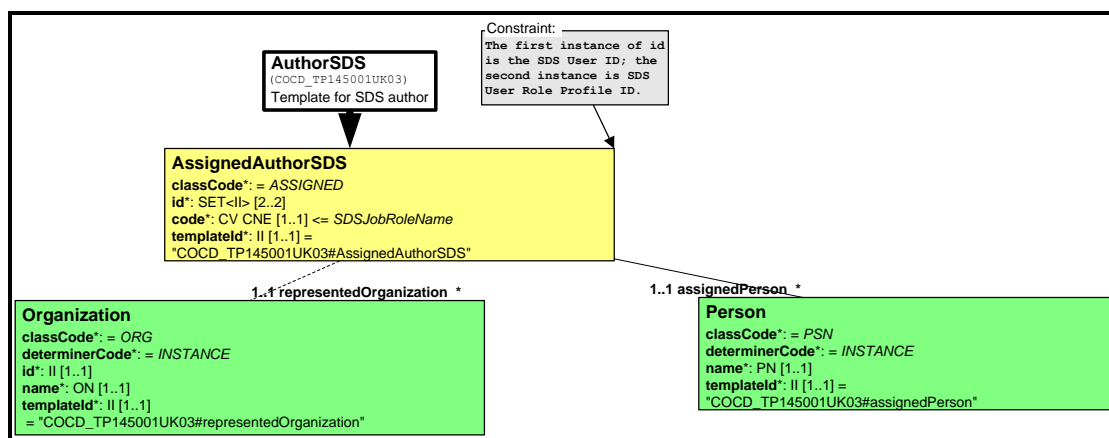

Where a template appears within a model a choice box with an abstract template class is used. The template class name although abstract must be unique within a model and therefore the template name may contain a number. This number is for uniqueness only and has no other significance.

Examples of abstract template classes

The structural attributes `classCode` and `moodCode` where shown in an abstract template class (circled below) are only shown due to a tooling limitation and have no relevance. These elements can be ignored by deployed systems as this is a visual issue in the RMIM html diagram only and is not applicable to Tabular view schema or any other messaging artefact.

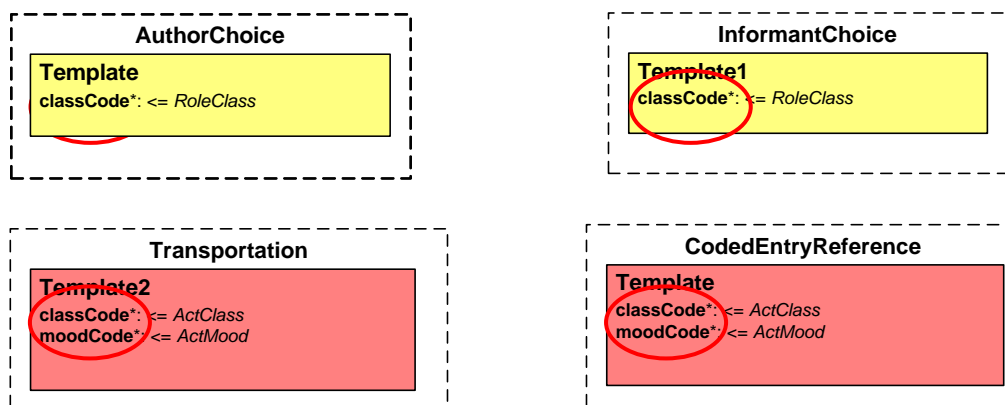

3.1 Use of Templates in HSCIC CDA Domains

The following rules have been followed when designing models containing templates and must be followed when populating instances:

1. A template for an act **MUST** be entered by an actRelationship at the specified entry point, the **templateId** **MUST** be held in the focal act of the template and all other classes within that template. The **contentId** **MUST** be held in the actRelationship
2. A template for a role can only be entered by participation at the specified entry point, the **templateId** **MUST** be held in the focal act of the template and all other classes within that template. The **contentId** **MUST** be held in the participation
3. **templateId** and **contentId** will always follow the above rules; nesting of templates does not change these rules. Therefore, when templates are nested the child template does not refer to its parent in any way.
4. All mandatory and required classes and attributes in the template shall be included and populated accordingly
5. Optional classes and attributes in the template may be included so long as they conform to the specification of that class/attribute
6. Outbound act relationships or participations contained in the template allow templates to be included within templates
7. Class clone names in the template models, tabular views are for clarity of specification only and in message instances, they shall comply with the names in the balloted CDA schema.

Note: - When the template is a reference (ActRef) template and the class is only present for CDA compliancy then **templateId** will not be present. See the section on References for further details.

3.2 Attributes Used with the Template Mechanism

The two attributes used with the template mechanism are `templateId` and `contentId` and the usage of these attributes are described in the following sections.

- [templateId](#)
- [contentId](#)

templated

Used to indicate which template is being used. HSCIC has adopted a “sandbag” approach in that the templated is present in every class within the template and identifies the template and the class or association name within the template.

Note: - when a class name is only present for CDA compliancy as per some reference, (ActRef) templates then the CDA class names are used and templated is not used to reduce xml size. The template schema enforces this.

Why className or associationName in templated ?

As the HSCIC implementation uses the templated extension as an aid for transformation and validation of the xml instances then the templated must contain the element names as they appear in the instance. This may equate to the class name or association name dependant on where in the instance the templated occurs.

The following rules apply to the format of templated

- If the class is the first class in the template (focalAct) then the templated is the format of Template Artefact Identifier#className
- If the class is a participation then the templated is the format of Template Artefact Identifier#className
- If the class is a relationship then the templated is the format of Template Artefact Identifier#className
- In all other cases the templated is the format of Template Artefact Identifier#associationName

Carried in instance

- oid="2.16.840.1.113883.2.1.3.2.4.18.2"
- Extension – fixed to value as stated in the model. Format is Template Artefact Identifier "#"className or associationName

“on the wire” Example with className

```
<templated root="2.16.840.1.113883.2.1.3.2.4.18.2" extension="COCD_TP145001UK03#AssignedAuthorSDS"/>
```

“on the wire” Example with associationName

```
<templated root="2.16.840.1.113883.2.1.3.2.4.18.2" extension="COCD_TP145001UK03#assignedPerson"/>
```

Example template to illustrate templated usage

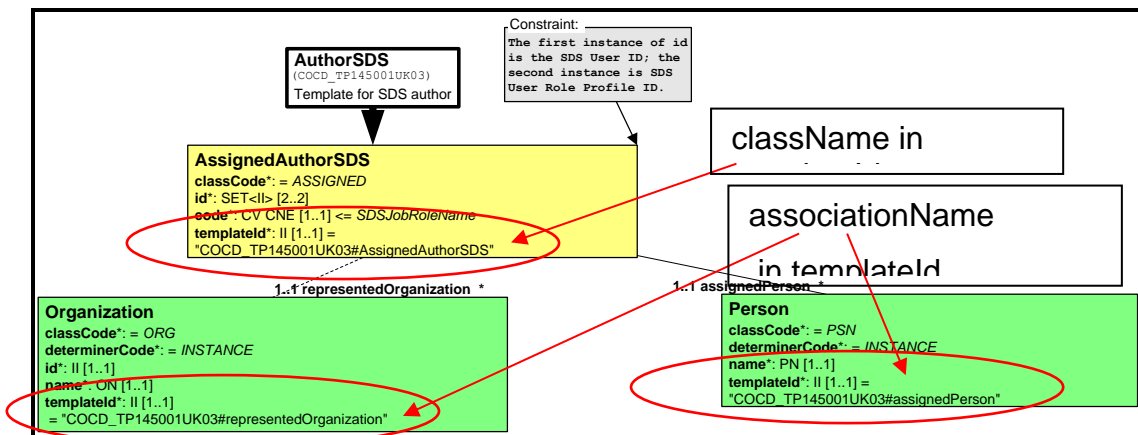

contentId

This is maintained in HSCIC namespace as it is a localisation.

The namespace is `xmlns:npfittc="NPFIT:HL7:Localisation"` and is used with schema generation.

contentId is a forward pointer to the template used and is carried in the participation or relationship that is immediately prior to the template.

The contentId is modelled using a constraint box on a RMIM (HL7 model) and the constraint has the format of NPFIT-nnnnnn#type of class constrained

Examples of contentId constraints on models

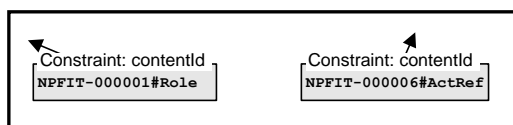

contentId carried in “on the wire” instance

- oid="2.16.840.1.113883.2.1.3.2.4.18.16"
- extension – the templated of the focal act of the template being used.

“on the wire” example

```
<npfittc:contentId root="2.16.840.1.113883.2.1.3.2.4.18.16" extension="COCD_TP146027UK04#Treatment"/>
```

In the HL7 RMIMs, the constraint on contentId is shown using a constraint box indicating the constraint used. This constraint contains a list of one or more templates that may be used at this point within the instance. The list of allowable templates is held in the Template configuration file. See the [TemplateConfig.xml](#) section for more information on this configuration file. The abstract template class is linked to the html grids which show the allowable templates.

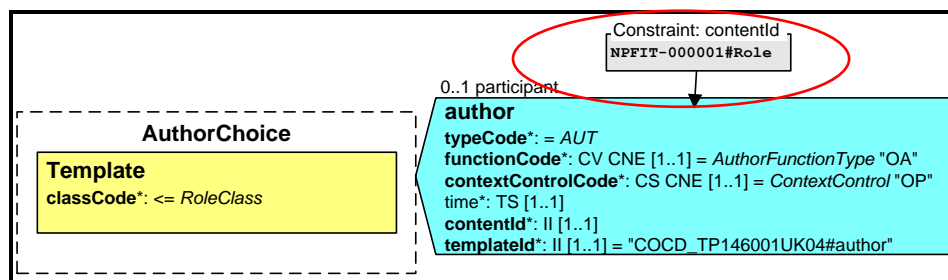

3.3 Template Types

There are three basic types of HSCIC CDA templates

1. Role templates
2. Act templates
 - a. Coded Entry
 - i. Simple
 - ii. Complex
 - b. Non Coded Entry
3. Act reference templates

3.3.1 Role Templates

These templates are used to constrain roles

Examples of roles that people have that could be constrained using a template

- Clinicians (GP , Nurse, Surgeon, Pharmacist etc)
- Carers , Family members and relatives (mother, father , wife etc)

The role templates only constrain at a level such as SDS clinician or relative and not at individual roles such as GP due to the large number of roles involved in patient care. The templates use a code carried in the roleCode attribute to identify the type of role the person is playing when there is a requirement to do so.

***Important note* :-** The position where the role template is applied to constrain the roles contained in a HSCIC CDA document governs which attributes can be used in the template design. This means that very similar templates are sometimes required to constrain the same role in different positions within a document. These limitations are unavoidable and are confined to the role templates. They do however cause complications when transforming the “on the wire” format to the “templated” format or the “templated” format to “on the wire” format as mappings are no longer a simple 1 to 1 but vary dependant on the position in the documents that the templates occur. This problem has been solved by using a much more complex transform

In the Illustration at the end of this section the Health Care Facility template (1) and the Service Delivery Location Details template (2) both constraint a place where a clinical event happened but due to the position in the clinical document use different classes and attributes.

This table highlights the attributes used and differences due to position in CDA document as per the illustration. The numbers referred to in the table refer to the identifying numbers in the illustration.

Template	Class	Attributes
HealthCare Facility (1)	Organization	<ul style="list-style-type: none"> • id • name • telecom • addr (Address)
Service Delivery Location Details (2)	Organization	<ul style="list-style-type: none"> • id • desc (Description)
HealthCare Facility (1)	Place	<ul style="list-style-type: none"> • name • addr (Address)
Service Delivery Location Details (2)	Place	<ul style="list-style-type: none"> • name • desc (Description)

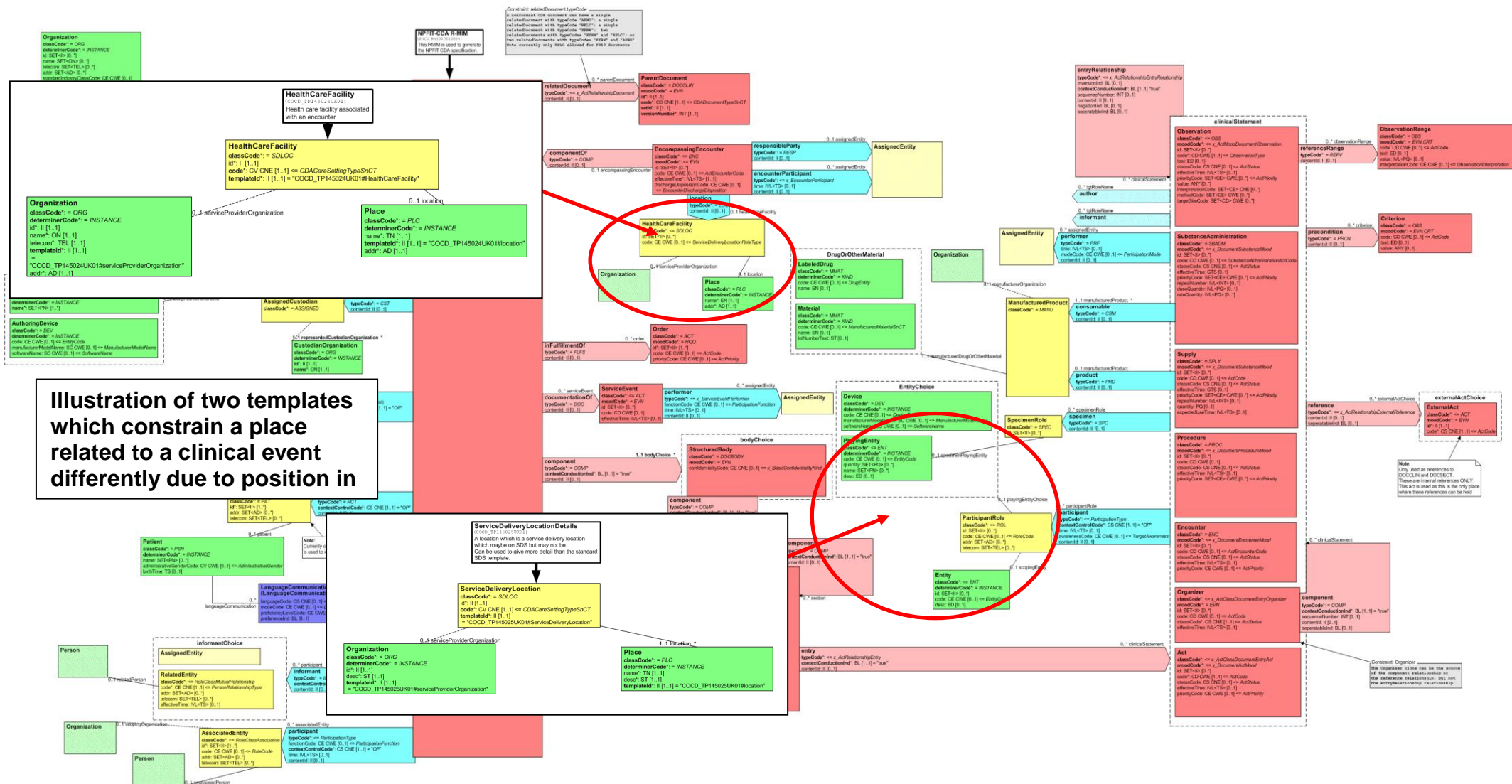

3.3.2 Role Grids

The Role grids are shown below, note later role grids may have guidance on the usage of the templates.

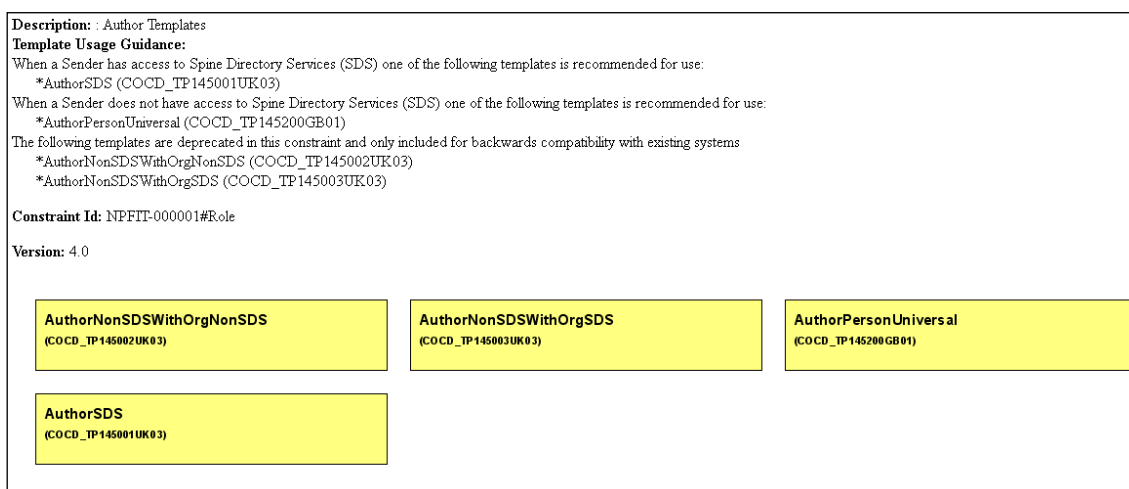
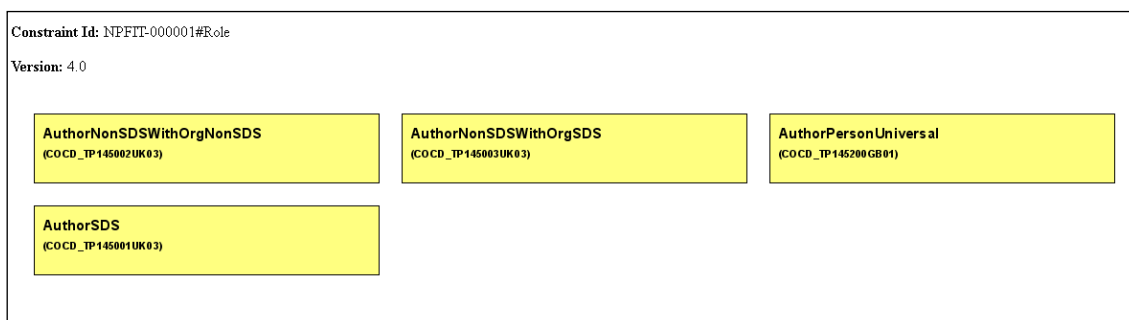

3.3.3 Act Templates

Act templates are mainly used to constrain HSCIC CDA Coded entries but can be used to constrain any Act class contained in a HSCIC CDA document, for example, CDA Encompassing Encounter and Text section are not coded entries but are constrained using Act templates. HSCIC CDA Act templates can therefore be classified as coded entry templates or non-coded entry templates. This classification only applies to the templates when used with HSCIC CDA.

3.3.4 Coded Entry Templates

Coded entry templates can be divided into two subtypes

- Simple
- Complex

Simple Coded Entry Templates

These templates only have a single act and optionally one or more participations

The information being carried is relatively simple consisting of a single Act carrying a SNOMED CT term normally (but a code from another code system may be used sometimes) and the people, organisations, place devices etc involved in the act. The people, organisations, place devices involved in the act would be role templates. These templates are defined as specific templates for one or more of the following reasons

- To allow a SNOMED CT subset or subsets to be tightly constrained (bound) to a particular template (Usually the primary reason when a subset is used)
- To allow a single fixed code to be used (Usually the primary reason when a fixed code is used)

- To allow a more human readable understanding of the templates use though the use of specific class names (business names)
- To allow the tight constraining of the cardinality of participations

Abstract illustration of simple code entry template

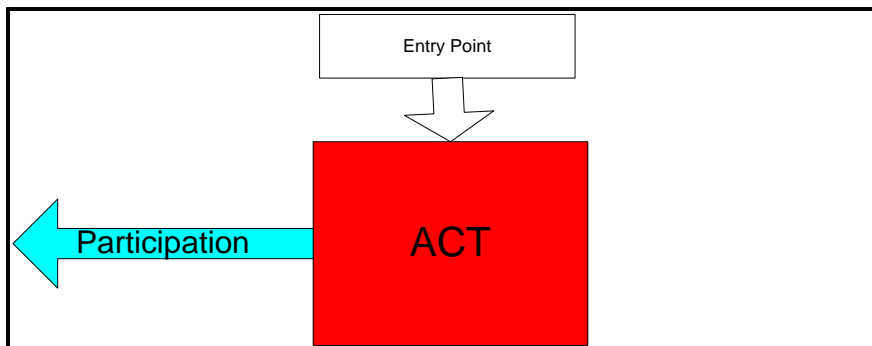

Simple coded entry act template example

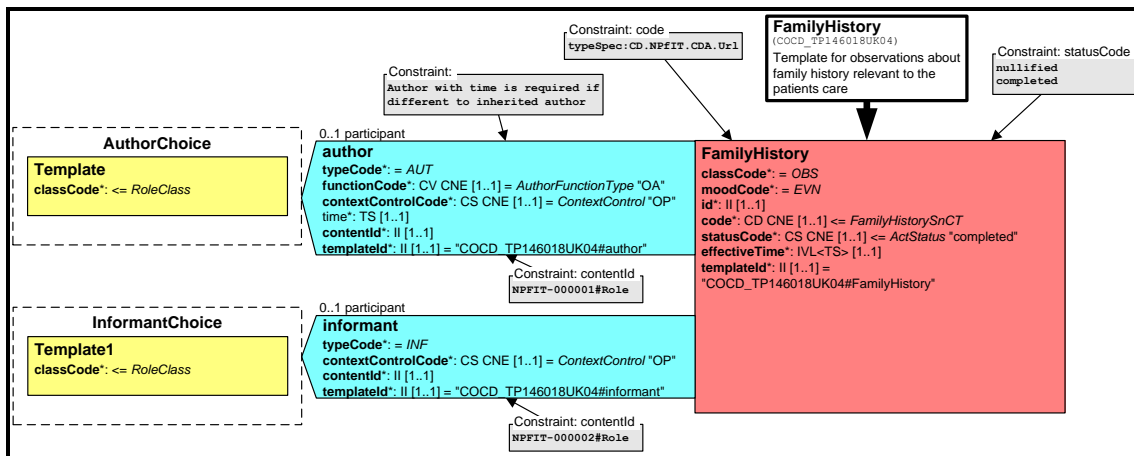

Complex coded entry templates

These templates have multiple acts, optionally one or more participations and optionally one or more act relationships. These templates may also have any number of other HL7 classes or include other templates.

These templates are used to constrain complex information such as medication or allergies. These templates are defined as specific templates for one or more of the following reasons

- To allow a SNOMED CT subset or subsets to be tightly constrained (bound) to a particular template (Usually a primary reason when a subset is used)
- To allow a single fixed code to be used (Usually a primary reason when a fixed code is used)
- To allow a more human readable understanding of the templates use though the use of specific class names (business names)
- To allow the tight constraining of the cardinality of participations
- To allow the tight constraining of the cardinality of ActRelationships
- To allow constraining of the structure of information carried in a HSCIC CDA coded entry (Can also be a primary reason)
- To allow specific business rules to be enforced by a template
- To create a single large template instead of multiple simple templates where appropriate

Abstract illustration of basic complex template

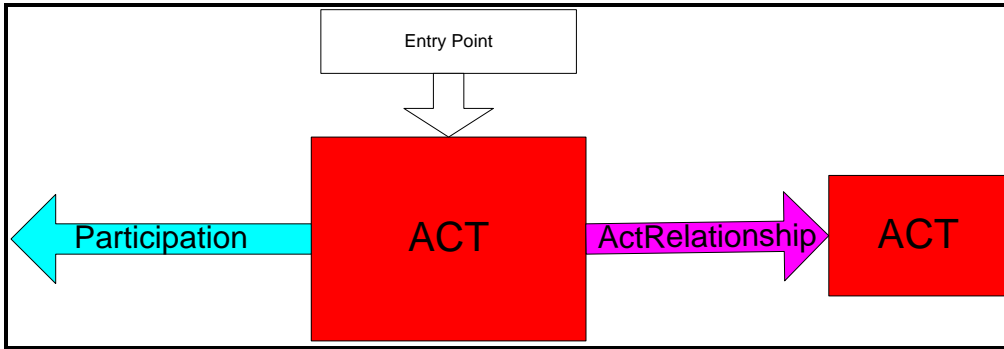

Complex Act template example

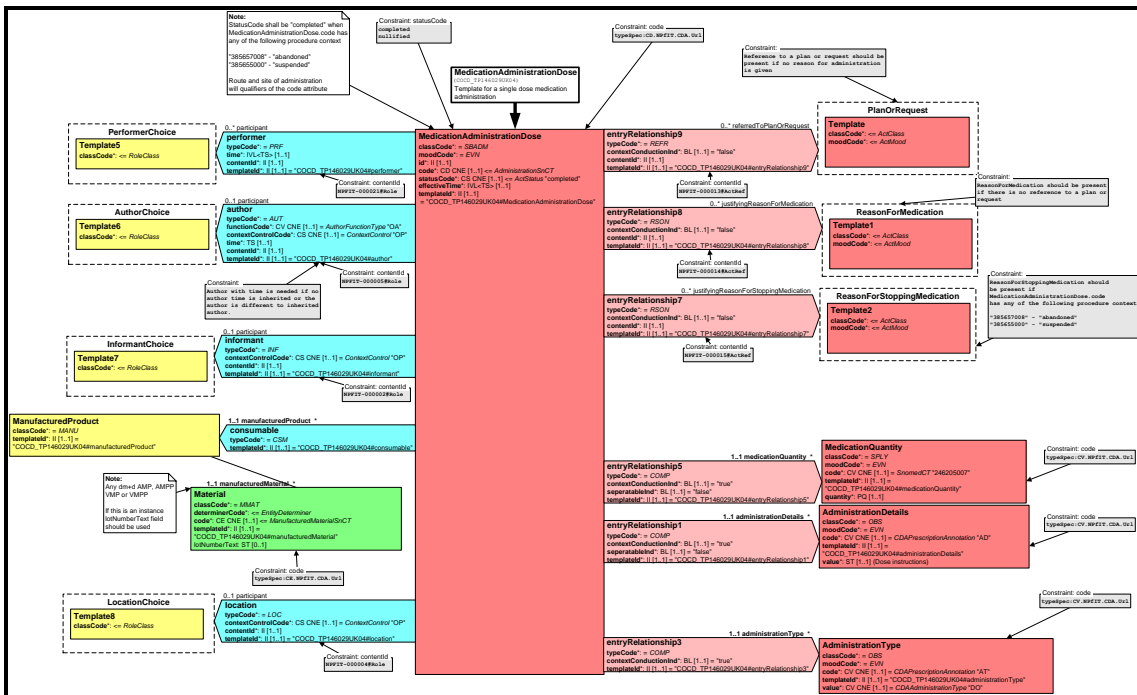

3.3.5 Act Reference templates

These templates are used to constrain references between templates and normally only have 1 Act class. The referencing between parts of a HL7 message is defined in the HL7 Clinical Statement Pattern Domain and a reference to another act is known as an ActRef. CDA was specified prior to Act references (ActRefs) therefore the mechanism has not been implemented directly in CDA. HSCIC has implemented a CDA compliant format of referencing using templates. The reference templates may have other classes present for CDA conformance. For full details of Act Reference templates, see the [section on the use of ActRefs in documents](#)

3.4 Template Artefact id Format

The template identifiers have been allocated in several groups to allow easier recognition.

- All role templates have the format COCD_TP145nnnUKnn
- All act templates have the format COCD_TP146nnnUKnn
- All reference templates have the format COCD_TP147nnnUKnn

- Note later templates may use GB instead of UK for the realm

4 HSCIC CDA Localisation

The HSCIC implementation uses the following attributes as localisation extensions

- [messageType](#)
- [contentId](#)
- [recipientRoleCode](#)

These attributes use an NPfIT namespace and are documented in the relevant sections within this document.

4.1 messageType

This is maintained in the HSCIC namespace.

`xmlns:npfitc="NPFIT:HL7:Localisation"`

The namespace is `xmlns:npfitc="NPFIT:HL7:Localisation"` and is used with schema generation.

This is used to hold the messageType including the version of the message associated with the document. When there are different definitions (versions) of the same document type this attribute provides a mechanism to distinguish between the different definitions (versions). This mechanism is required because documents stored on PSIS have their interaction wrappers removed which removes the identifiers available for versioning.

For example the Emergency Department Event document may change over time but there is no way of telling which iteration of the document has been received without using messageType.

“on the wire” Example of document without messageType

```
<code code="185291000000100" codeSystem="2.16.840.1.113883.2.1.3.2.4.15"/>
<title>Emergency Department Event</title>
```

“on the wire” Example of document with messageType indicating version 06 of Emergency Department Event document

```
<npfitc:messageType root="2.16.840.1.113883.2.1.3.2.4.18.17" extension="POCD_MT150001UK06"/>
<id root="9F03B8A2-8643-4348-86EA-0C7AF05C8402"/>
<code code="185291000000100" codeSystem="2.16.840.1.113883.2.1.3.2.4.15"/>
<title>Emergency Department Event</title>
```

An illustration of a document RIM with messageType attribute

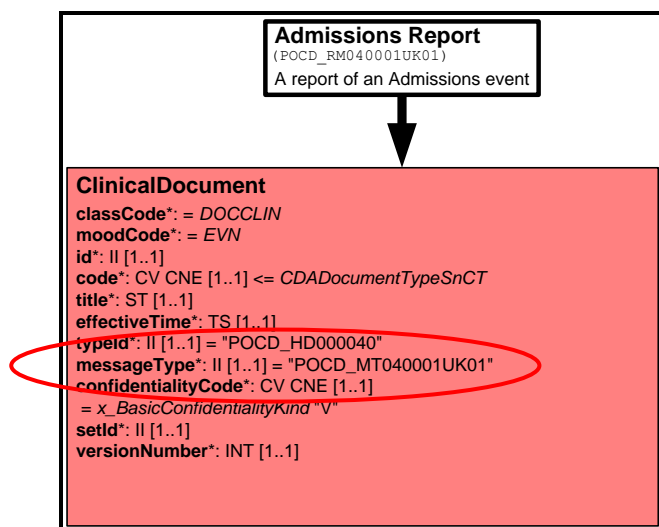

4.2 contentId

This attribute is used with templating and is documented in the Attributes Used with the Template Mechanism [section](#)

4.3 recipientRoleCode

This attribute is used to carry a code, code system and displayName to indicate the role of the recipient of the document when known. This attribute is required as a localisation because CDA does not support role.code in IntendedRecipient class.

The following points should be noted about this attribute.

- The vocabulary used is CWE allowing any local code that describes a recipients role to be used
- The vocabulary has a default OID which can be used when no OID is available on the sending system
- The fact that there is a default OID means the code should not be used for processing as the meaning of each code cannot be uniquely determined.
- The displayName can be rendered by receiving system

This is maintained in the HSCIC namespace.

`xmlns:npfittlc="NPFIT:HL7:Localisation"`

The namespace is `xmlns:npfittlc="NPFIT:HL7:Localisation"` and is used with schema generation.

“on the wire” Example of document with recipientRoleCode using default OID

```
<npfittlc:recipientRoleCode codeSystem="2.16.840.1.113883.2.1.3.2.4.17.196" code="1G" displayName="General Practitioner"/>
```

Recipient template with recipientRoleCode

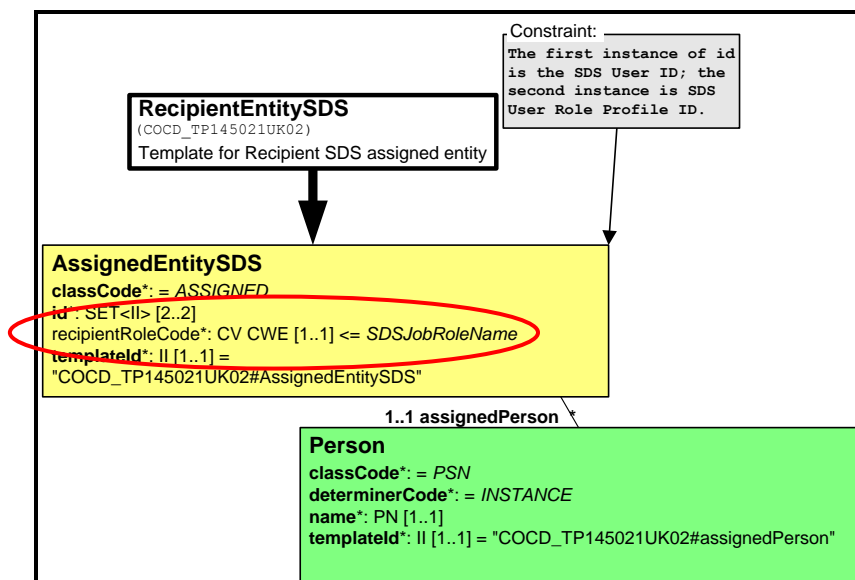

5 TemplateConfig.xml

Usage – Informative

This configuration file included in the message specification holds the information required to control the usage of templates in a domain profile(s) within a message specification. Changes to this file will highlight changes to constraints on the document instance. These changes may not be easily determined elsewhere in the message specification by a human reader although an html version detailed later will give some information. Although not necessarily required to implement a HSCIC CDA templated domain details of this file are included to give a better insight of the templating mechanism. The file aids generation of message artefacts but may also be used to determine changes to constraints on the models / documents programmatically.

This file has the following key functions.

- Indicates the allowed templates at a given point in the parent RMIM / instance
- Indicates the parent RMIM models that reference the templates
- Holds descriptions to be included in the html grids
- Used to generate the domain and template schema fragments
- Used as an aid to generate schematron for cross validation
- Used to generate template cross reference file
- Uses a schema to enforce / validate the structure of the TemplateConfig file

The format of this file is critical to the templating mechanism and so is described in full detail below.

5.1 TemplateConfig.xml element definitions

Basic elements file layout-showing nesting of elements

```
<Templates title="" version="">
  <ChangeHistory/>
  <DomainList>
    <domain id=""/>
  </DomainList>
  <StatusFlag>
    <value id=""/>
  </StatusFlag>
  <Template id="" version="" status="">
    <comments>
      <p/>
    </comments>
    <parentModel>
      <domain id="">
        <id/>
      </domain>
    </parentModel>
  </Template>
</Templates>
```

Templates element contains

- Version of the file
- Title - indicates which message specification version uses this configuration
- Schema location

Example templates element

```
<Templates version="8.0" title="Template configuration file for MIM 6.3" xmlns:xsi="http://www.w3.org/2001/XMLSchema-instance"
xsi:noNamespaceSchemaLocation="../dt/TemplateConfig.xsd">
```

ChangeHistory element at file level contains

- Details of change history for this version of the file at file level

Example ChangeHistory element

```
<ChangeHistory>
  <p>Version 3.0</p>
  <p>Removed discontinuation template from everywhere except plan medication administration</p>
  <p>Updated all version numbers due to change in template mechanism</p>
  <p>Removed NPFIT-000015#Role as not used</p>
  <p>New NPFIT-000025#Role for receiver of medication supply</p>
  <p>Removed discontinuation ref from all constraints except plan and request for medication administration</p>
</ChangeHistory>
```

DomainList element contains

- A list of domains and the id of each domain which are configured using this file

Note: - ids stated are for use within this file only.

Example DomainList element

```
<DomainList>
  <domain id="DIS">Discharge</domain>
  <domain id="EDT">Emergency Department</domain>
  <domain id="OPS">Outpatients</domain>
  <domain id="SES">Sealed Envelopes</domain>
  <domain id="NUL">Nullification</domain>
  <domain id="HLP">HealthSpace</domain>
  <domain id="TEM">Templates</domain>
</DomainList>
```

StatusFlag element contains

- List of all the allowed states of a constraint

```
<StatusFlag>
  <value id="A">Active</value>
  <value id="D">Deprecated</value>
  <value id="P">Proposed</value>
</StatusFlag>
```

Template element contains

- id of the constraint
- version of constraint
- status of constraint

Example Template element

```
<Template id="NPFIT-000001#ActRef" version="4.0" status="A">
```

Comments element contains

- A xhtml fragment which holds the text that appears in the html grids

An html grid is an auto-generated html file and a diagram in .png format which is used within the MIM to allow navigation within templated html representations of the domain models.

Note: - navigation within the domain models using the html grids does NOT represent the level of nesting within the XML instance.

Example html grid text

```
Tue Jul 31 15:37:00 BST 2007
Description: Author Templates
Template Id Constraint: NPFIT-000001#Role
Version: 3.0
```

Example html grid

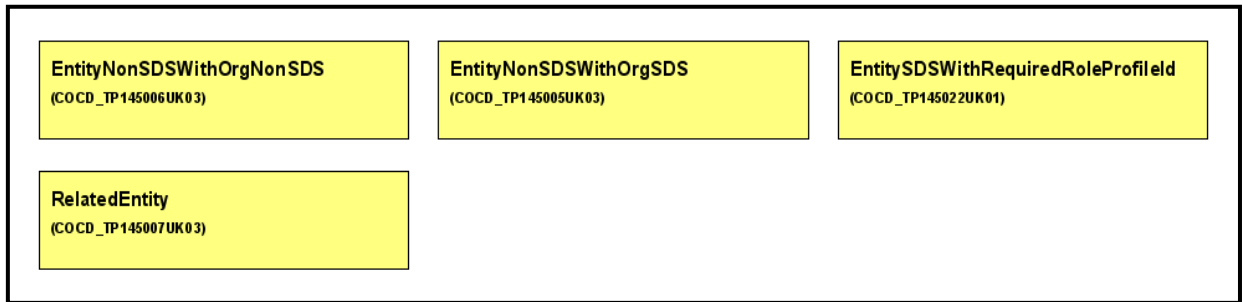

Example comments element

```
<comments>
  <p>Encounter Templates</p>
</comments>
```

ChangeHistory element at constraint level contains

- Change history of the individual constraint

Example ChangeHistory element

```
<ChangeHistory>
  <p>Version 4.0</p>
  <p>Removed COCD_TP146043 UK03 and COCD_TP146045 UK03 for sealing changes</p>
</ChangeHistory>
```

parentModel element contains

- domain id / ids from the domain list that use this constraint
- id of all the parent models that use this constraint

Example parentModel element

```
<parentModel>
  <domain id="DIS">
    <id>POCD_MT150001UK06</id>
  </domain>
</parentModel>
```

id element contains

- ids of all the templates allowed in this constraint

```
<id>COCD_TP146001UK04</id>
<id>COCD_TP146002UK04</id>
<id>COCD_TP146003UK04</id>
<id>COCD_TP146004UK04</id>
<id>COCD_TP146005UK04</id>
<id>COCD_TP146006UK04</id>
<id>COCD_TP146007UK04</id>
<id>COCD_TP146008UK04</id>
```

6 Template Cross Reference

This is a messaging artefact in html format generated from the [templateConfig.xml](#) file, which indicates the following

- Which constraint is used in which model
- Which version of the constraint is used
- Status of constraint
- Domain
- Model
- Description of model
- Class which is templated
- Links to the above artefacts

Example entry in the template cross reference

16 Constraint : NPFIT-000014#ActRef [version : 3.0] [status : Active]			
Domain	Model	Description	Class
Templates	COCD_TP146029UK04	MedicationAdministrationDose	ReasonForMedication
Templates	COCD_TP146030UK04	MedicationAdministrationCourse	ReasonForMedication
Templates	COCD_TP146031UK04	PlanMedicationAdministration	ReasonForMedication
Templates	COCD_TP146034UK04	RequestMedicationAdministration	ReasonForMedication

7 Template versioning

This section defines the rules regarding when, why and how a template is up versioned

The following are the HSCIC rules for when a template is up versioned (examples of each are included later).

1. The RMIM changes in content or structure
2. A different constraint on contentId is used in the RMIM
3. Removal of a template from a constraint on contentId
4. A different vocabulary is used in the RMIM
5. Any change that is reflected as a change to schema
6. Change to constraints imposed by the template using textual constraints carried in the tabular view.

The following changes do not require an up-version

- Version of contentId constraint is up versioned due to the version of one or more templates within that contentId constraint has changed
 - (note version of contentId constraint is not shown on RMIM)
- Addition of template to contentId constraint
- Change to tabular view text when new text further explains or clarifies the class or attribute

Up-version examples

In the following illustration, the template structure remains unchanged therefore can be used across MIM releases but the contentId constraint carried in the RMIM changes to allow different references to other templates.

- A. The first version of the template
- B. The new version of the template with MIM 7.0 series references
- C. The next version of the template with changed MIM 6.0 series references
- D. The next version of the template with changed MIM 6.0 series references
- E. The next version of the template with changed MIM 7.0 series references

Note: - the arrows are present to indicate that the template is the same structurally across the domains except for the contentId constraint.

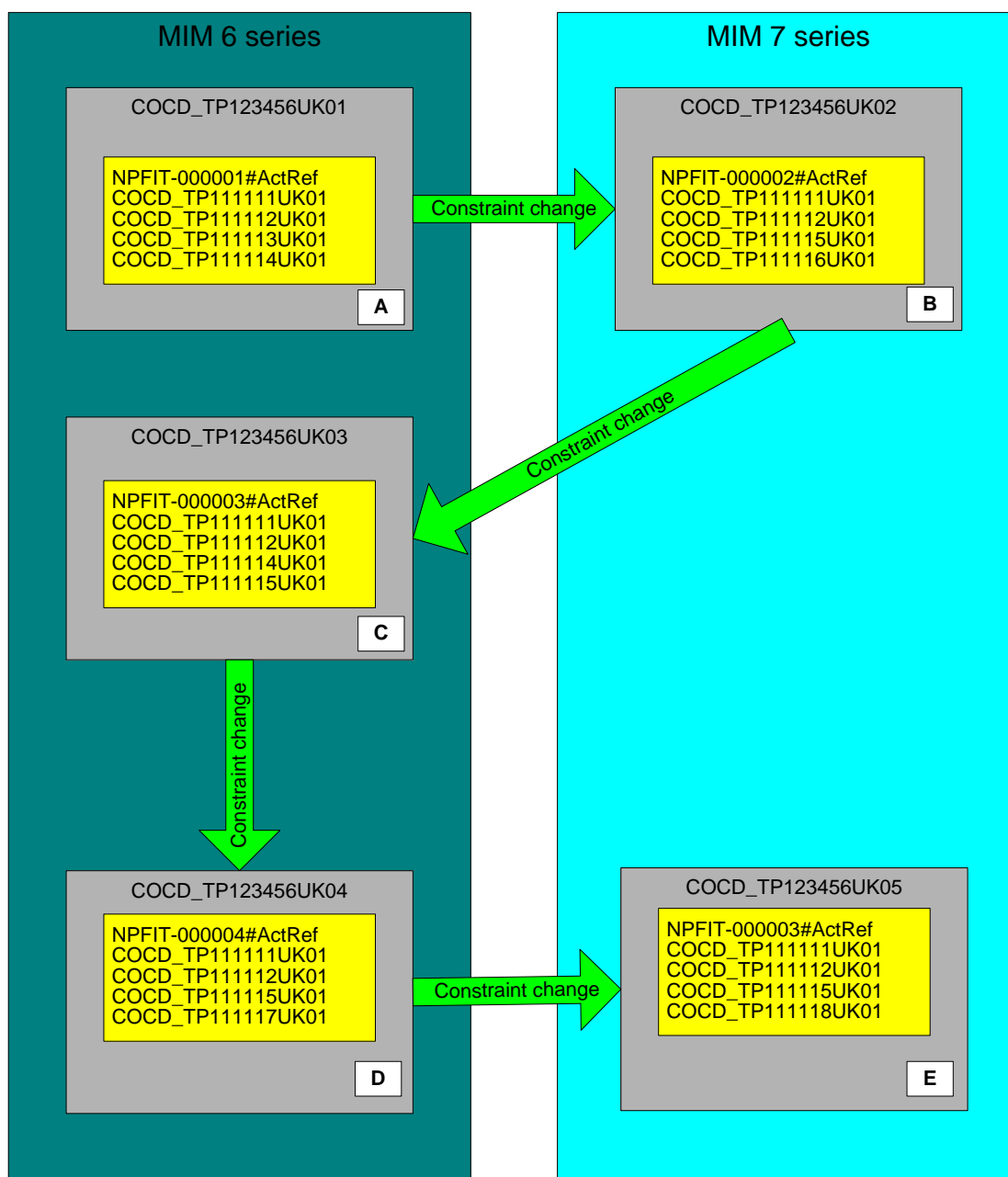

The following illustration shows that when a contentId constraint version is up-versioned to allow newer versions of templates to be used it does not require an up-version of the template only up-version of contentId constraint

Note: - the arrows are present to indicate that the template is the same structurally across the domains except for the constraint.

- A. The first version of the template first version of contentId constraint
- B. The same version of the template with the updated MIM 7.0 series references using a new version of the contentId constraint for new versions of the templates
- C. The same version of the template with changed MIM 6.0 series references using a new version of the contentId constraint some new versions of the templates
- D. The same version of the template with changed MIM 6.0 series references using a new version of the contentId constraint some new versions of the templates

- E. The same version of the template with changed MIM 7.0 series references using a new version of the contentId constraint with new versions of the templates

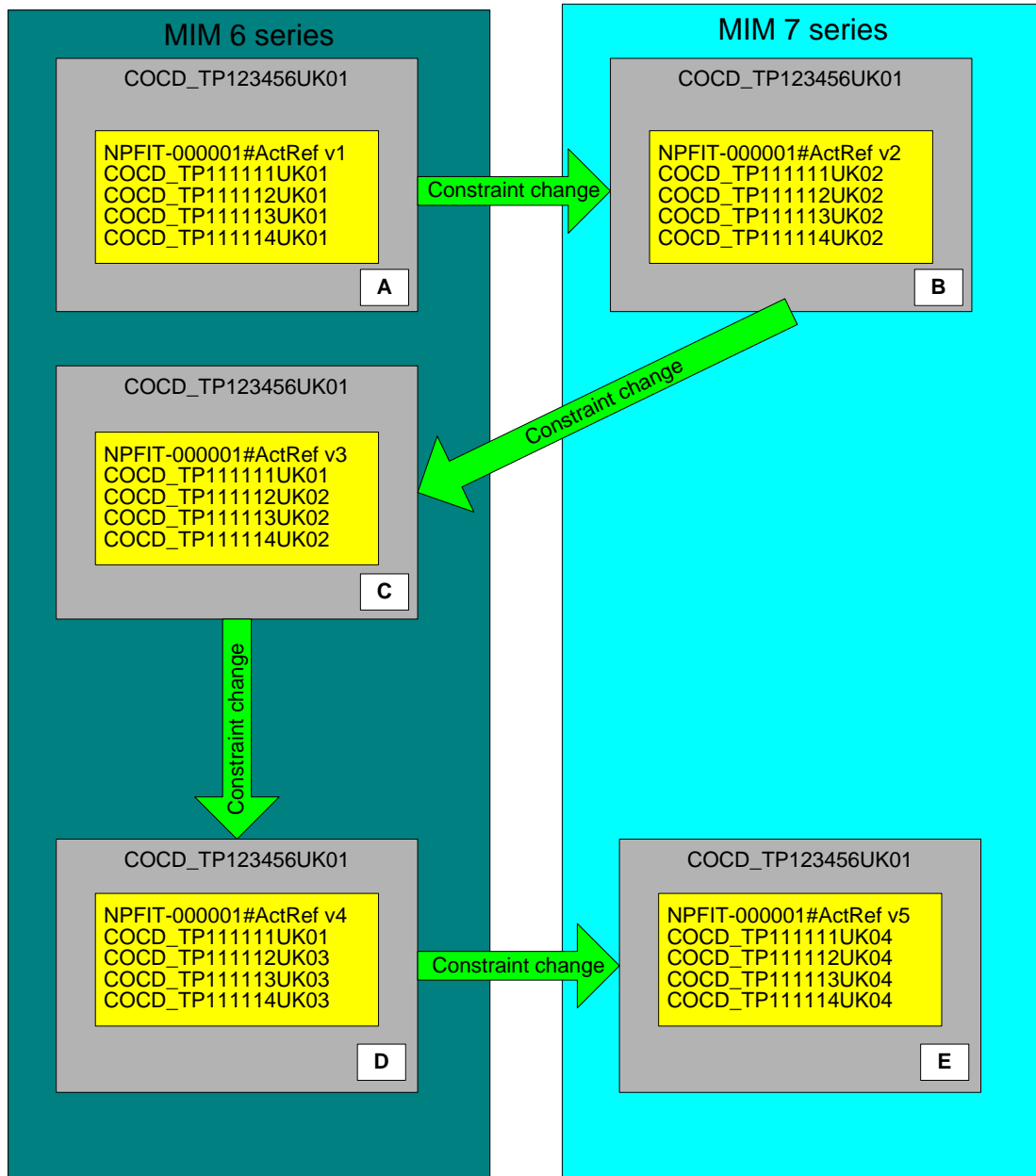

The following illustration shows when a template version is up-versioned for structure changes due to changes in the business requirements. **Note** that the version numbers of a template in a given MIM or DMS are NOT sequential

- A. The first version of a procedure template
- B. The new version of the procedure template with no informant as not required for MIM 7.0 domains
- C. The new version of the procedure template for MIM 6.0 series which no longer uses informant to align with MIM 7.0 but adds a component observation
- D. The new version of the procedure template for MIM 6.0 series adds another component observation
- E. The new version of the procedure template for MIM 7.0 series which does not use observations but a procedure instead
- F. The new version of the procedure template for MIM 7.0 series which allows a choice of procedure or observation
- G. The new version of the procedure template for MIM 7.0 series which allows a choice of procedure or observation is now used in the MIM 6.0 series which would always be the aim but in reality not always possible.

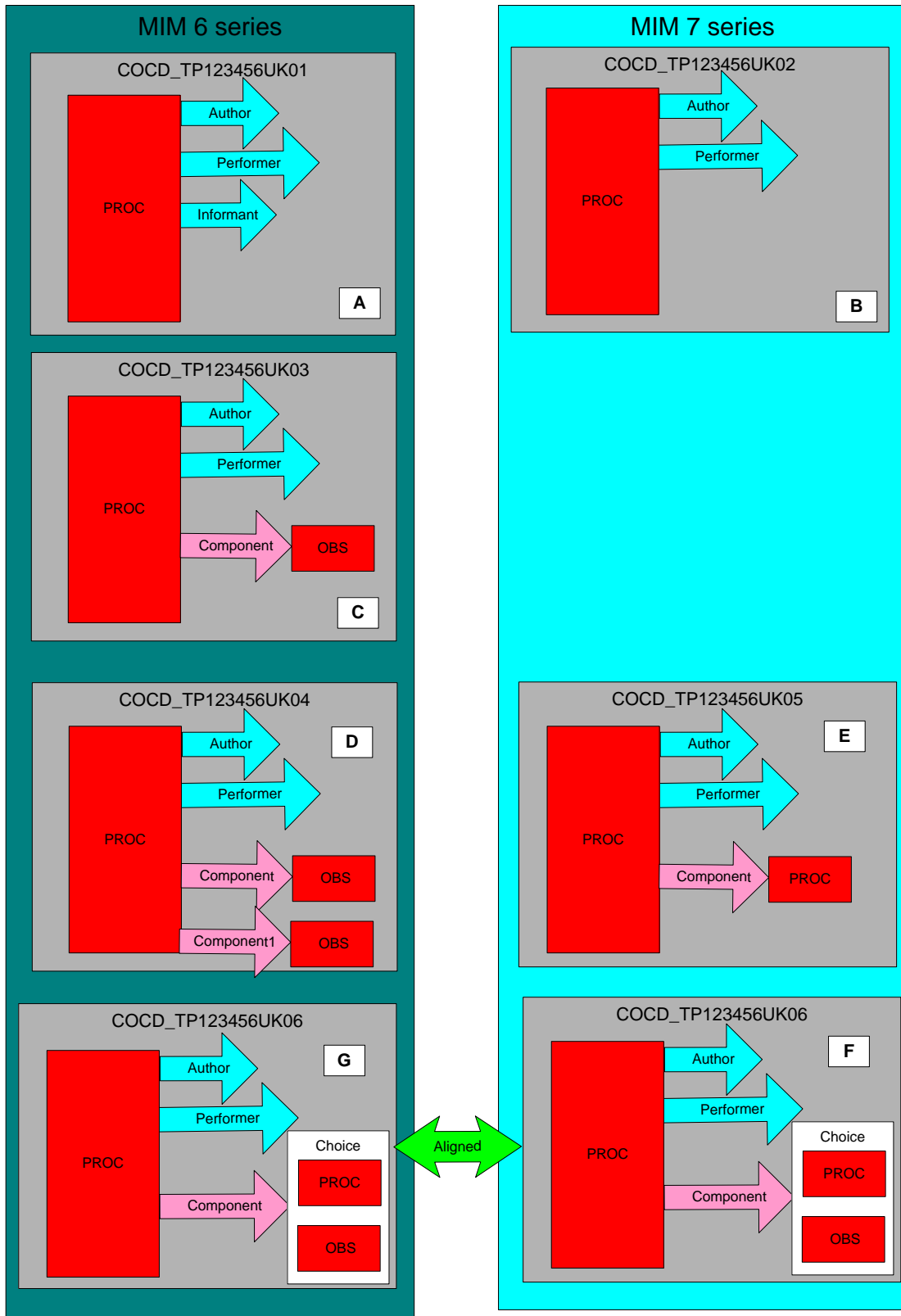

8 Datatype Constraining in Templates

The NHS CDA RMIM does NOT constrain HSCIC “on the wire” instances and therefore this section is only relevant to TMS interactions.

The NPfIT CDA RMIM constrains the balloted CDA RMIM datatypes for HSCIC “on the wire” instances.

A template may further constrain the datatype or datatype flavor used in the NPfIT CDA RMIM or NHS CDA RMIM. For example the observation class in the NPfIT CDA RMIM uses “CD” datatype in its code attribute and this is constrained to “CV” datatype in some templates.

This means that an “on the wire” instance that had translation in the code element would pass validation against the NPfIT CDA schema (level 1 validation) but would fail against the template schema (level 2 validation) because the template had the code attribute constrained to “CV”.

There are other occurrences of datatype constraining in templates which will have the same result of passing level 1 validation but failing level 2 validation, some examples of which are listed below

- SET<II> constrained to II
- CWE constrained to CNE
- GTS constrained to TS
- SET<TEL> constrained to TEL
- SET<AD> constrained to AD
- SET<PN> constrained to PN
- ANY constrained to PQ
- ANY constrained to IVL<TS>
- ANY constrained to CD

For further information on datatypes refer to the datatype section in the message specification or the latest HL7 Ballot pack

9 Use of default with mandatory codes

There are idiosyncrasies with some earlier domains (GP Summary for example) with regards to the use of a default value with a mandatory code. Previous versions of the schema generator used during MIM development did not create a correct schema if a model had a class with a mandatory code and a default value assigned to the code. The earlier version of the generator made the mandatory code optional when a default was used. This has now been corrected from MIM 6.3.00 and is not relevant to the DMS.

Previous version of schema generator (prior to MIM 6.3.00)

Extract from tabular view

[1..1] [M] statusCode (CS {CNE:ActStatus }) { Default="completed" }

Extract from schema

```

<xs:element name="statusCode">
  <xs:complexType>
    <xs:complexContent>
      <xs:restriction base="CS">
        <xs:attribute name="code" use="optional" default="completed"/>
        <xs:simpleType>
          <xs:restriction base="cs">
            <xs:enumeration value="nullified"/>
            <xs:enumeration value="active"/>
            <xs:enumeration value="completed"/>
          </xs:restriction>
        </xs:simpleType>
      </xs:restriction>
    </xs:complexContent>
  </xs:complexType>
</xs:element>

```

Current version of schema generator (post MIM 6.3.00)

Extract from tabular view

[1..1] [M] statusCode (CS {CNE:ActStatus }) { Default="completed" }

Note: - the default value is not enumerated in the schema and must be taken from the tabular view.

This is because schema does not allow "default" when use="required".

```

<xs:element name="statusCode">
  <xs:complexType>
    <xs:complexContent>
      <xs:restriction base="CS">
        <xs:attribute name="code" use="required"/>
        <xs:simpleType>
          <xs:restriction base="cs">
            <xs:enumeration value="nullified"/>
            <xs:enumeration value="completed"/>
            <xs:enumeration value="active"/>
          </xs:restriction>
        </xs:simpleType>
      </xs:restriction>
    </xs:complexContent>
  </xs:complexType>
</xs:element>

```

10 Use of Required Participations and Relationships

Within the HSCIC templates there are occurrences of required participations and relationships which cannot easily be modelled with a cardinality of 1..1 and conformance of required as CDA has not used nillable (`xsi:nil="true"` is not allowed) within its schema. The use of nil would have been the preferred option to use when there are required participations or relationships as this is the cleanest technical solution, which would have produced simpler and smaller instances.

Within the templates, other ways of modelling this are used and are detailed below.

Participations and relationships that are 1..1 required cannot use a HL7 null flavor so there are two methods used within the message specifications.

1. Include all required classes and attributes required for CDA schema compliancy in the instance. **Note:** - option 1 cannot be used where a participant or relationship is used with templates due to `contentId` being mandatory and requiring a `templateId` as a value.
2. Make the required participation or relationship optional and state the conformance in the tabular view.

Example of method 1 implementation for a required participation used within a template

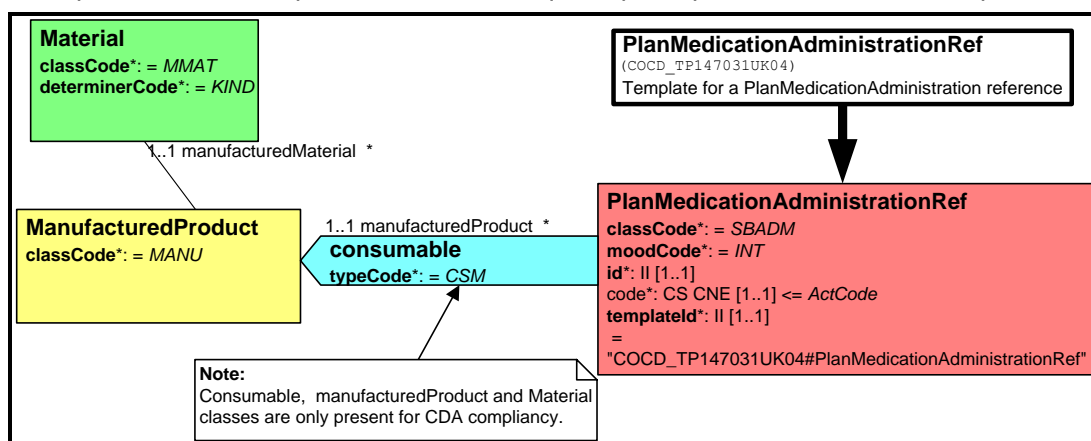

The above reference template has `manufacturedProduct` and `manufacturedMaterial` as 1..1 required for CDA schema compliancy. The `consumable`, `ManufacturedProduct` and `Material` classes are only present for CDA conformance and therefore they do not contain `templateId` but use the class names as per CDA.

Example reference in “templated” format instance

```
<COCD_TP147031UK04.PlanMedicationAdministrationRef moodCode="INT" classCode="SBADM ">
  <code nullFlavor="NA"/>
  <id root="D92DCC40-EF24-11DB-A1B4-F5CA408FF127"/>
  <templateId root="2.16.840.1.113883.2.1.3.2.4.18.2"
  extension="COCD_TP147031UK04#PlanMedicationAdministrationRef"/>
  <consumable typeCode="CSM">
    <manufacturedProduct classCode="MANU">
      <manufacturedMaterial determinerCode="KIND" classCode="MMAT"/>
    </manufacturedProduct>
  </consumable>
</COCD_TP147031UK04.PlanMedicationAdministrationRef>
```

Example of how method 2 implementation for a required participation is used within a template.

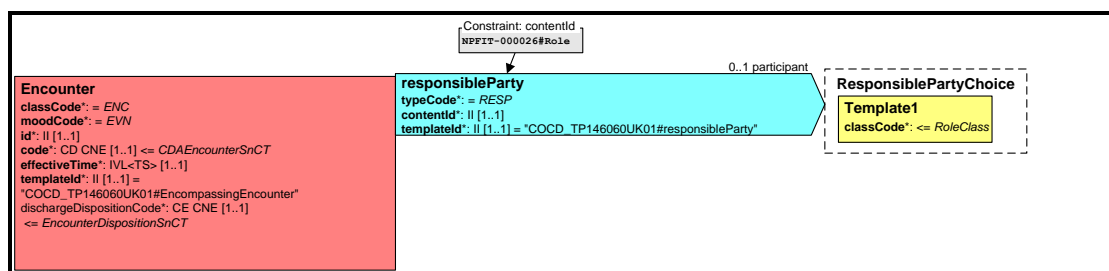

The above template requires the responsibleParty to be 1..1 required (which is a tightening of the generic CDA model) as responsibleParty is templated then it is modelled as 0..1 optional and the conformance is stated in the tabular view.

Tabular view extract

<p>[0..1] responsibleParty</p>	<p>The person responsible for the Encompassing Encounter.</p> <p>Note this participation is required to be included if available on the sending system.</p>
--------------------------------	---

This sort of tabular view constraint is tested for conformance during system testing by the National Integration Centre for Assurance.

11 Use of References in Documents (Actrefs)

What is an ActRef ?

The referencing between parts of a HL7 message is defined in the HL7 Clinical Statement Pattern Domain and a reference to another act is known as an ActRef. CDA was specified prior to Act references (ActRefs) therefore the mechanism has not been implemented directly in CDA. HSCIC has implemented a CDA compliant format of referencing using templates. The reference templates may have other classes present for CDA conformance

During development of the GP Summary message, a message simplification exercise was undertaken. The aim of this exercise was to:-

- Reduce message size
- Reduce level of nesting
- Restrict / remove the use of recursive relationships

The main change to message structure was to use references between clinical statements instead of nesting them within each unless absolutely necessary. This method has also been used with the HSCIC CDA implementation.

The references are only currently allowed to be internal to the document as references between statements in other documents are not currently supported by PSIS.

All references (ActRefs) within the HSCIC implementation are templated and have RMIMs, tabular views and schemas produced just like any other template.

These templates are:-

- Machine generated
- Have the artefact id in the format of COCD_TP147nnnUKnn
- Have class codes fixed to classCode of target class (or use relevant HL7 x_domain)
- Have mood codes fixed to moodCode of target class (or use relevant HL7 x_domain)

- Use schema to enforce correct attributes and usage

Reference templates are modelled as below in the parent RMIM (HL7 model)

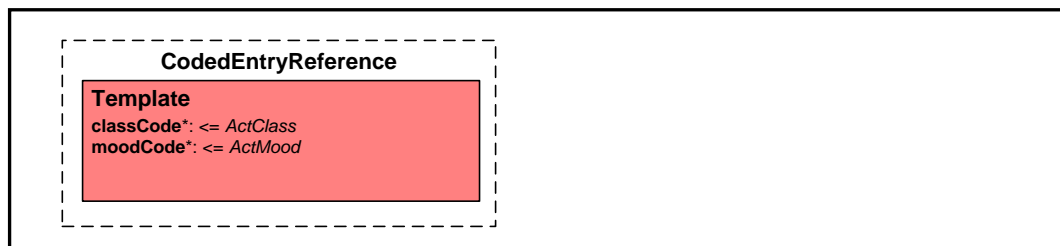

Note: - CDA has not implemented references using Actrefs as per the current Clinical Statement in HL7 therefore reference (Actref) templates sometimes carry more attributes or in some case more addition classes than would be expected. This is because reference templates are constrained versions of the class being referenced and the class being referenced may have required or mandatory attributes or in some cases class may have required or mandatory associated classes.

It is worth mentioning at this point that CDA does have a generic Act class and some external references, however the class codes and mood codes are too tightly constrained to allow all references to all classes to use this generic act as an ActRef. It was decided that for consistency and a cleaner technical solution all reference classes would be constraints of the class to be referenced.

Some templated references examples are detailed below.

Note: - The template example class names differ from the on the wire CDA class names shown in the balloted CDA RMIM extracts.

The actual CDA balloted RMIM (HL7 model) is shown here indicating that manufacturedProduct and manufacturedMaterial are required 1..1 on SubstanceAdministration class within the clinical statement choice. Therefore, any reference, which is a constraint of this, must include these classes

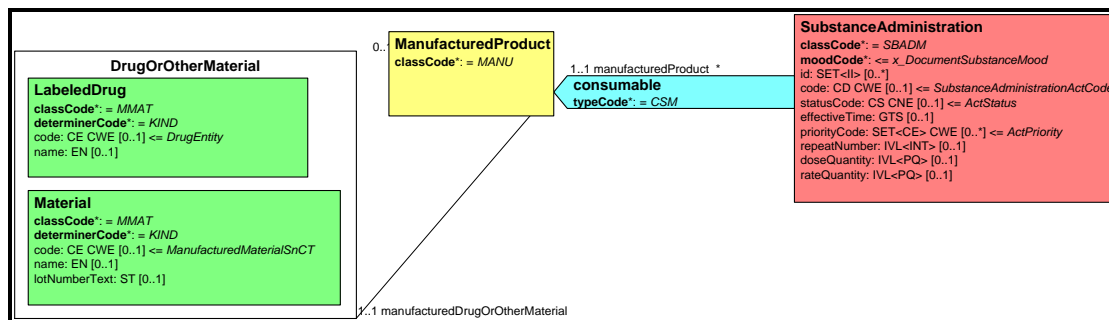

The reference to a substance administration is shown below with the required classes included.

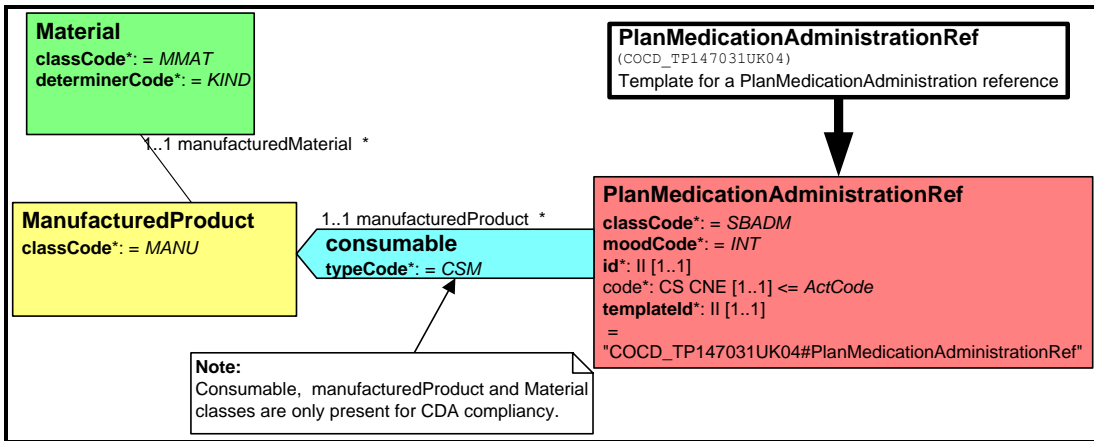

Where this is the case, only the elements and attributes required for CDA compliancy are included in the “templated” instance as below.

```
<COCD_TP147031UK04.PlanMedicationAdministrationRef moodCode="INT" classCode="SBADM ">
  <code nullFlavor="NA"/>
  <id root="D92DCC40-EF24-11DB-A1B4-F5CA408FF127"/>
  <templated root="2.16.840.1.113883.2.1.3.2.4.18.2"
  extension="COCD_TP147031UK04#PlanMedicationAdministrationRef"/>
  <consumable typeCode="CSM">
    <manufacturedProduct classCode="MANU">
      <manufacturedMaterial determinerCode="KIND" classCode="MMAT"/>
    </manufacturedProduct>
  </consumable>
</COCD_TP147031UK04.PlanMedicationAdministrationRef>
```

The CDA balloted RMIM (HL7 model) is shown here indicating that manufacturedProduct is optional on Supply.

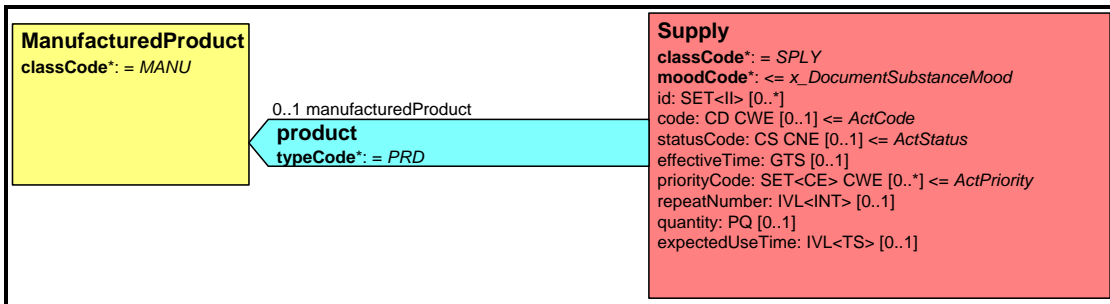

Therefore, any reference to a supply does not need to include the manufacturedProduct.

The reference to a supply is shown below

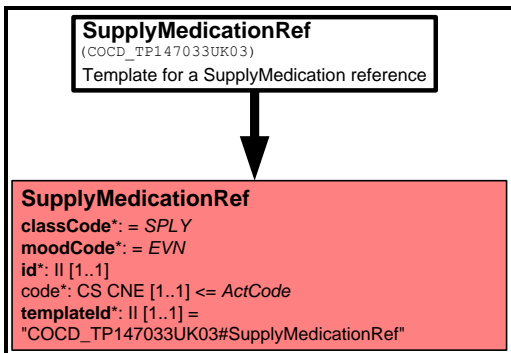

The Observation class in the Balloted CDA RMIM (HL7 model) has code as 1..1 required therefore any reference template must have a code attribute present.

```

Observation
classCode*: <= OBS
moodCode*: <= x_ActMoodDocumentObservation
id: SET<I> [0..*]
code*: CD CWE [1..1] <= ObservationType
statusCode: CS CNE [0..1] <= ActStatus
effectiveTime: |VL<TS> [0..1]
priorityCode: SET<CE> CWE [0..*] <= ActPriority
value: ANY [0..*]
interpretationCode: SET<CE> CNE [0..*]
methodCode: SET<CE> CWE [0..*]
targetSiteCode: SET<CD> CWE [0..*]
    
```

The BloodPressure reference template, which is a reference to an observation, must have the code attribute present.

```

BloodPressureRef
(COCD_TP147013UK03)
Template for a BloodPressure reference

↓

BloodPressureRef
classCode*: = BATTERY
moodCode*: = EVN
id*: || [1..1]
code*: CS CNE [1..1] <= ActCode
templateId*: || [1..1] =
"COCD_TP147013UK03#BloodPressureRef"
    
```

All reference templates which have classes / attributes which appear only for CDA compliancy have this clearly stated in the RMIMs and / or tabular views.

Attributes are set to a null flavor of "NA"

Example

```

<code nullFlavor="NA"/>
    
```

11.1 Act Reference Grids

All the templates that allow references to other templates have grids and schemas for the allowed references for the given template, however the use of an allowed reference is dependant on the domain making use of the template being referred to. All reference grids have text stating this constraint but this is not enforceable by current MIM artefacts.

Wed Sep 19 15:11:40 BST 2007

Description: :

Reference Templates

Constraint :- For a reference to be used within a domain, the template referred to must be utilised within that domain

Template Id Constraint: NPFIT-000014#ActRef

Version: 3.0

AllergicOrAdverseReactionEventRef (COCD_TP147022UK03)	AllergyPropensityRef (COCD_TP147025UK03)	BloodPressureRef (COCD_TP147013UK03)
DiagnosisRef (COCD_TP147011UK03)	FamilyHistoryRef (COCD_TP147018UK03)	FindingOrganizerRef (COCD_TP147017UK03)

This constraint needs enforcing though schematron etc during conformance testing. All uses of references need checking during conformance to ensure references refer to the instance of the template and that the instance exists.

For example the format of a reference to a diagnosis are schema tested (classCode, moodCode etc) but whether the UUID of the reference is the UUID of a diagnosis cannot be tested by schema. Likewise the presence of a reference to procedure needs to be tested to ensure the instance of the referred to procedure is present in the message instance.

Note: On in later DMS format message specifications the grids have changed, the unused reference templates marked as not allowed and the link removed as show below.

ActivityOfDailyLivingRef (COCD_TP147067UK04) [Not allowed]	AdministrativeProcedureRef (COCD_TP147024UK03)	AlcoholIntakeRef (COCD_TP147003UK03)
AllergicOrAdverseReactionEventRef (COCD_TP147022UK03)	AllergyPropensityRef (COCD_TP147025UK03)	AssessmentEventRef (COCD_TP147065UK04) [Not allowed]
AssessmentRef (COCD_TP147100UK04) [Not allowed]	BloodPressureRef (COCD_TP147013UK03)	CarePlanRef (COCD_TP147075UK04) [Not allowed]
DiagnosisRef (COCD_TP147011UK03)	DischargeRef (COCD_TP147030UK03) [Not allowed]	FamilyHistoryRef (COCD_TP147018UK03)
FinancesRef (COCD_TP147071UK04) [Not allowed]	FindingOrganizerRef (COCD_TP147017UK03)	FindingRef (COCD_TP147012UK03)
HeightRef (COCD_TP147015UK03)	HousingRef (COCD_TP147060UK04) [Not allowed]	InvestigationRef (COCD_TP147019UK03)
LifeStyleRef (COCD_TP147001UK03)	MedicationAdministrationCourseRef (COCD_TP147030UK04)	MedicationAdministrationDoseRef (COCD_TP147029UK04)
MentalEmotionalWellBeingRef (COCD_TP147070UK04) [Not allowed]	MobilityRef (COCD_TP147069UK04) [Not allowed]	PatientMovementRef (COCD_TP147037UK03)
PersonalPreferenceRef (COCD_TP147020UK03)	PhysicalWellBeingRef (COCD_TP147066UK04) [Not allowed]	PlanMedicationAdministrationRef (COCD_TP147031UK04)
ProvisionOfAdviceAndInformationRef (COCD_TP147023UK03)	RequestMedicationAdministrationRef (COCD_TP147034UK03)	RequestMedicationSupplyRef (COCD_TP147032UK03)
RiskToPatientRef (COCD_TP147026UK03)	RiskToPersonRef (COCD_TP147010UK03)	SecurityAbuseDiscriminationRef (COCD_TP147072UK04) [Not allowed]
ServiceRef (COCD_TP147021UK03)	SmokingRef (COCD_TP147002UK03)	SocialOrPersonalCircumstanceRef (COCD_TP147004UK03)
SupplyMedicationRef (COCD_TP147033UK03)	TemperatureRef (COCD_TP147016UK03)	TreatmentRef (COCD_TP147027UK03)
WeightRef (COCD_TP147014UK03)		

12 Use of displayName and originalText in HSCIC CDA Documents

HSCIC has defined the rules for the use of “displayName” and “originalText” attributes for use with HSCIC CDA domains as below:-

1. Where a system captures the SNOMED CT code through a user selection e.g. a drop down then the “displayName” the user selected will be incorporated into the messaged textual narrative AND will be carried in the coded entry template.
2. Where a system captures native language narrative and is then subsequently SNOMED CT coded the “originaltext” (that originally captured by the UI) should be carried in the message textual narrative, with the “displayName” associated with the SNOMED CT code incorporated into the coded entry template.

Note1 :- In both instances above the originaltext reference linking mechanism will be used to link the coded entry to the relevant text as per [referencing Between Coded Entries and Text section](#)

Note2 :-original text should not be carried in the originalText attributes of the coded entry template but only in the associated text section.

13 Referencing Between Coded Entries and Text

Referencing between coded entries (templates) and text is implemented using the ID attribute within content element and the value attribute within the reference element of the originalText element as illustrated below. The contentId element should enclose the referred to text as below

```
<content ID="a3">Referred to text</content>
```

Note:- Documents should ideally not use contentId without a reference or a reference without a contentId. Systems MUST however be able to process documents, which contain these inaccuracies.

13.1 Illustration of referencing



13.2 Graphical representation of referencing using single template

The illustration below gives an example of how a table of medication supplied (contained in a text section) could be referenced from a medication coded entry template.

Medication on Discharge

<paragraph><content ID="a1">Medication on Discharge</content></paragraph>

Medication	Dose	Quantity
Voltarol Rapid 50mg tablets.	one tablet 3 times daily	21 tablets

<td colspan="1" rowspan="1"><content ID="a2">Voltarol Rapid 50mg tablets.</content></td>
 <td colspan="1" rowspan="1"><content ID="a3">one tablet 3 times daily</content></td>

Ongoing Care

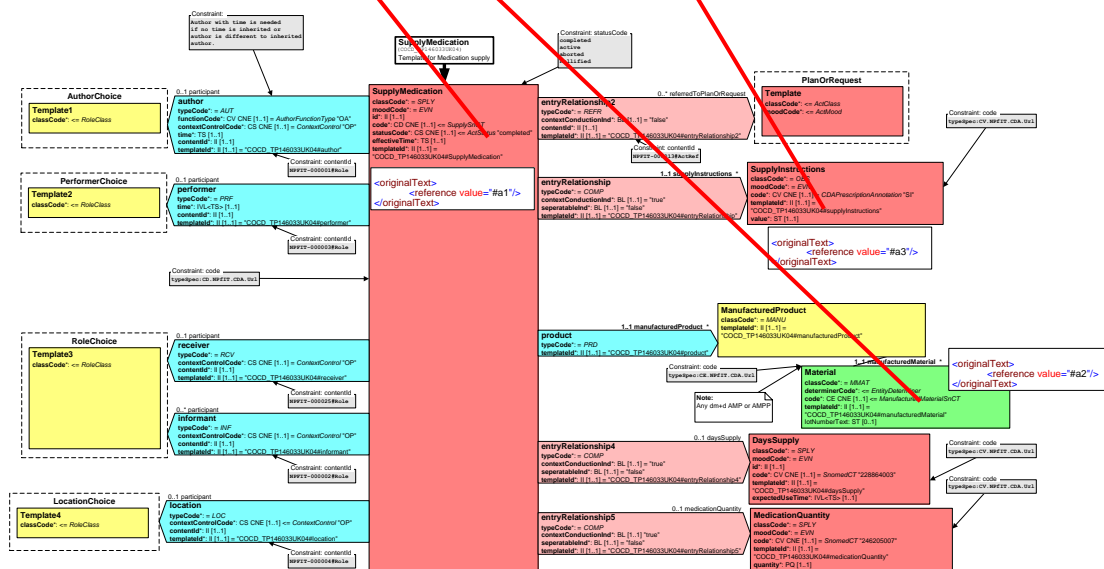

13.3 Graphical representation of referencing using multiple templates

The illustration below gives an example of how a bulleted list could be referenced from multiple templates (Treatment template (x2) and the Supplied Medication template).

Note: - the referencing mechanism is the standard CDA approach as shown in previous illustrations but full detail is omitted due to size of diagram.

Operative Course

- Lower Uterine segment Caesarean Section on 22-Sep-2006. <content ID="a1"></content>
- Spinal Anaesthesia. <content ID="a2"></content>
- Closure with absorbable Vicryl. <content ID="a3"></content>
- Twin delivery both babies fit and well.

Post Operative Course

- Mary has progressed well post op, her blood pressure remained stable through out. At time of discharge her sutures were clean, her uterus resorbing well. She still had some PV discharge but this is decreasing.
- She commenced breast feeding the twins.
- Contraceptive advice was given.
- Anti-D (Rh) immunoglobulin given.

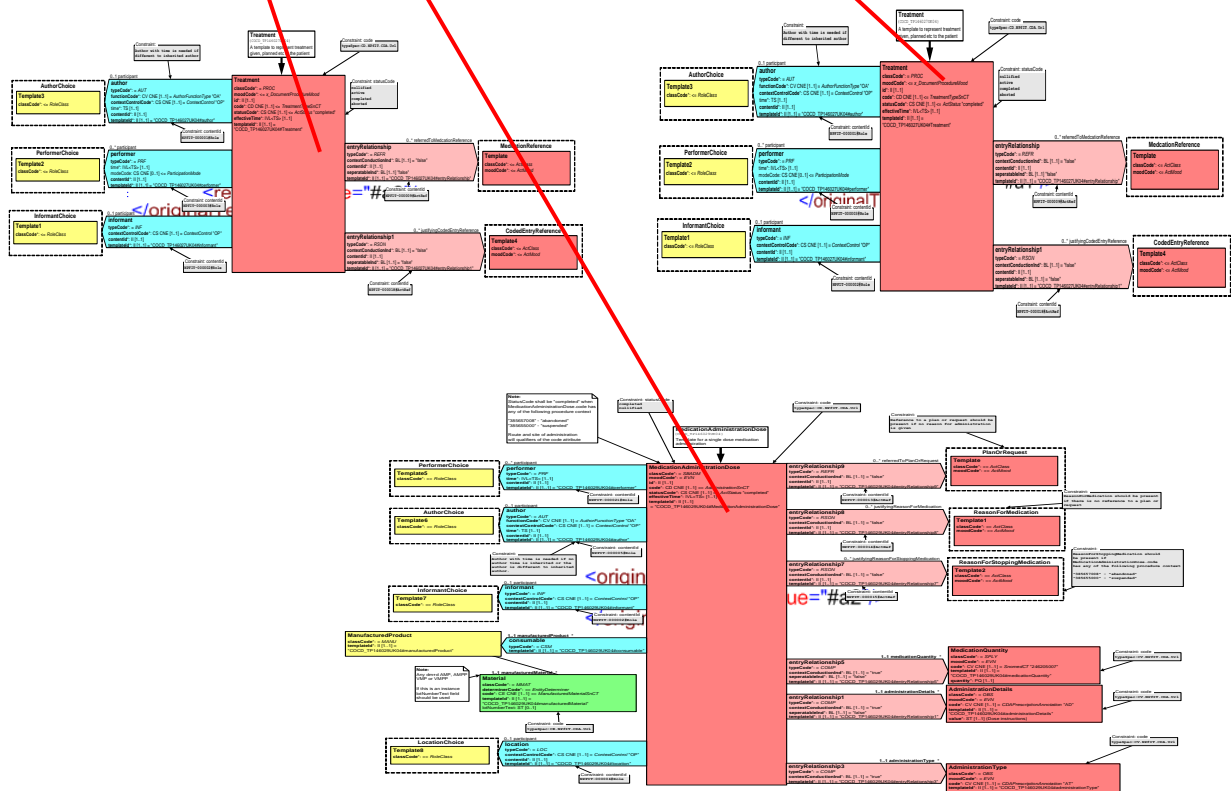

14 Data type Specialisations for Coded Elements to Allow CDA URL

Rationale

CDA provides a mechanism for linking between coded entries and supporting text through use of the originalText/reference/@value attribute, which has a datatype of URL. The common format for the value of this attribute is to prefix # before the identifier, thus forming a relative URL. During the HSCIC CDA implementation for CCN404, an issue with the use of this mechanism was found with the models.

The problem was with the additional constraints added to the HSCIC datatype schema for URL. The CDA schema (and the HL7 default one) is flexible to use anyURI to represent the URL. The HSCIC version of URL was previously modified to enforce constraints for domains within the message specification to exclude the use of relative URLs since these can become broken if fragments of the XML instance are processed independently. The following section explaining this refers to the template RMIMs. The NPfIT CDA RMIM or NHS CDA RMIM do not show the constraints as indicated in the template RMIMs, however the datatype constraints are applied to the associated “on the wire” schemas.

CDA states that the datatypes specification included with it in the normative release should be used for CDA documents. However, domains such as PDS and Medications Management require the tight version to be used to ensure conformant versions of telecoms addresses etc and these are already live. Two versions of the datatype schemas would cause too many issues with maintenance and changes required to the message specification structure. To overcome this problem, three more relaxed specialisations of the base HL7 datatypes have been created to cover:

- Concept Descriptor (CD)
- Coded Value (CV)
- Coded with Equivalentents (CE)

Though these are referred to as specialisations, there are in fact generalisations.

Specialisations

The specialisations all allow the above coded datatypes to contain a loose (non-local) URL in the value attribute of originalText/reference. The specialisation is applied to the coded element, which within it lists the specialisation on URL. The specialisations on the coded elements are:

- Concept Descriptor with CDA URL
- Coded Value with CDA URL
- Coded with Equivalentents with CDA URL

Within the RMIMs a constraint box is used by the schema generator to apply the specialisation to the schemas during development of message specifications.

Note :- 1 constraint is required per class, per attribute, that is required to be linkable.

14.1 Examples of URL specialisation constraint on code within RMIMs

Constraint on CD

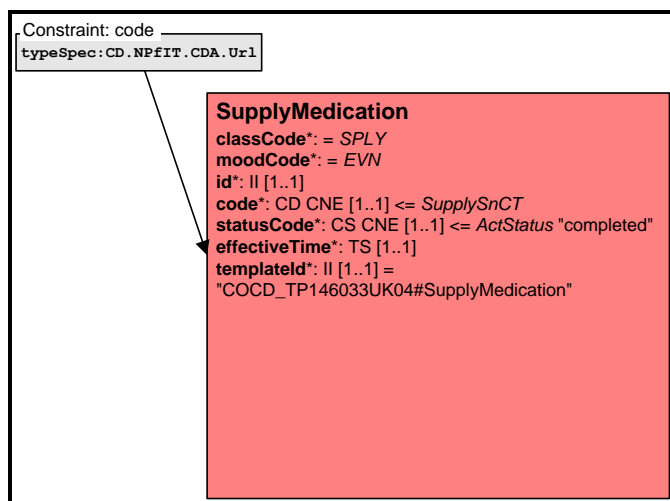

Constraint on CV

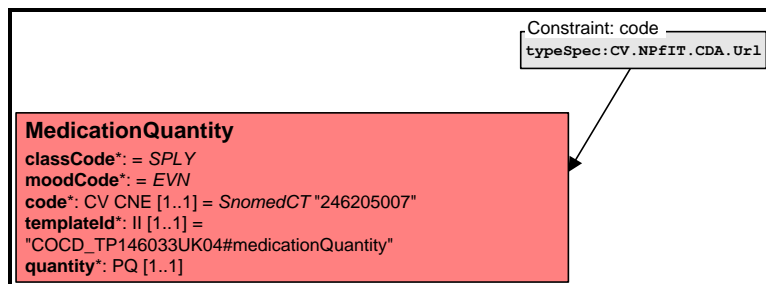

Constraint on CE

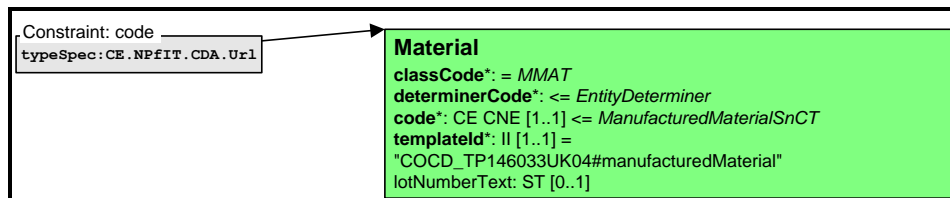

14.2 Concept Descriptor with CDA URL

Valid constraint of HL7 data types: CD.

This flavour is used where the original encoding uses the approved coding scheme for a message attribute but where there may be some text entered or selected by the user either by direct entry or by reference that is not identical to the display text or rubric associated with the code.

1 code	The primary code value originally used to encode a statement.
1 displayName	The text or rubric associated with the code.
1 codeSystem	An OID identifying the coding system from which the code is derived.
0 originalText	The full text associated with this code as selected, typed or seen by the author of this statement. <i>This may contain additional information that is not completely coded.</i>

“on the wire” Example xml

```
<!-- To indicate a code with the original text upon which the code was based for a "code" attribute of an observation class -->
<code code="195967001" codeSystem="2.16.840.1.113883.2.1.3.2.4.15" displayName="asthma">
  <originalText>
    <reference value="#a1"/>
  </originalText>
</code>
```

14.3 Coded Value with CDA URL

Valid constraint of HL7 data types: CV.

This flavour is used where the original encoding uses the approved coding scheme for a message attribute but where there may be some text entered or selected by the user either by direct entry or by reference that is not identical to the display text or rubric associated with the code.

1 code	The primary code value originally used to encode a statement.
1 displayName	The text or rubric associated with the code.
1 codeSystem	An OID identifying the coding system from which the code is derived.
0 originalText	The full text associated with this code as selected, typed or seen by the author of this statement. <i>This may contain additional information that is not completely coded.</i>

“on the wire” Example xml

```
<!-- To indicate a code with the original text upon which the code was based for a "code" attribute of an observation class -->
<code code="195967001" codeSystem="2.16.840.1.113883.2.1.3.2.4.15" displayName="asthma">
  <originalText>
    <reference value="#a1"/>
  </originalText>
</code>
```

14.4 Coded with Equivalents with CDA URL

Valid constraint of HL7 data types: CE.

This flavour is used where the original encoding uses the approved coding scheme for a message attribute but where there may be some text entered or selected by the user either by direct entry or by reference that is not identical to the display text or rubric associated with the code.

1 code	The primary code value originally used to encode a statement.
1 displayName	The text or rubric associated with the code.

1 codeSystem	An OID identifying the coding system from which the code is derived.
0 originalText	The full text associated with this code as selected, typed or seen by the author of this statement. <i>This may contain additional information that is not completely coded.</i>

“On the wire” Example xml

```
<!-- To indicate a code with the original text upon which the code was based for a "code" attribute of an observation class -->
<code code="195967001" codeSystem="2.16.840.1.113883.2.1.3.2.4.15" displayName="asthma">
  <originalText>
    <reference value="#a1"/>
  </originalText>
</code>
```

Note:- for all the URL datatypes above only a reference is provided in the originalText attribute which links to the text carried in the section.

14.5 CDA URL schema fragment

```
<xs:complexType name="CD.NPIT.CDA.Url">
  <xs:complexContent>
    <xs:extension base="ANY">
      <xs:sequence>
        <xs:element name="originalText" type="Cda.NPIT.ED" minOccurs="0"/>
        <xs:element name="qualifier" type="CR" minOccurs="0" maxOccurs="unbounded"/>
        <xs:element name="group" minOccurs="0" maxOccurs="unbounded">
          <xs:complexType>
            <xs:sequence>
              <xs:element name="qualifier" type="CR" maxOccurs="unbounded"/>
            </xs:sequence>
          </xs:complexType>
        </xs:element>
        <xs:element name="translation" type="CD" minOccurs="0" maxOccurs="unbounded"/>
      </xs:sequence>
      <xs:attribute name="code" type="cs" use="optional"/>
      <xs:attribute name="codeSystem" type="uid" use="optional"/>
      <xs:attribute name="codeSystemName" type="st" use="optional"/>
      <xs:attribute name="codeSystemVersion" type="st" use="optional"/>
      <xs:attribute name="displayName" type="st" use="optional"/>
    </xs:extension>
  </xs:complexContent>
</xs:complexType>
<xs:complexType name="CE.NPIT.CDA.Url">
  <xs:complexContent>
    <xs:restriction base="CD.NPIT.CDA.Url">
      <xs:sequence>
        <xs:element name="qualifier" type="CR" minOccurs="0" maxOccurs="0"/>
        <xs:element name="originalText" type="Cda.NPIT.ED" minOccurs="0"/>
        <xs:element name="translation" type="CD" minOccurs="0" maxOccurs="unbounded"/>
      </xs:sequence>
      <xs:attribute name="code" type="cs" use="optional"/>
      <xs:attribute name="codeSystem" type="uid" use="optional"/>
      <xs:attribute name="codeSystemName" type="st" use="optional"/>
      <xs:attribute name="codeSystemVersion" type="st" use="optional"/>
      <xs:attribute name="displayName" type="st" use="optional"/>
    </xs:restriction>
  </xs:complexContent>
</xs:complexType>
<xs:complexType name="CV.NPIT.CDA.Url">
  <xs:complexContent>
    <xs:restriction base="CE.NPIT.CDA.Url">
      <xs:sequence>
        <xs:element name="originalText" type="Cda.NPIT.ED" minOccurs="0"/>
        <xs:element name="translation" type="CD" minOccurs="0" maxOccurs="0"/>
      </xs:sequence>
      <xs:attribute name="code" type="cs" use="optional"/>
      <xs:attribute name="codeSystem" type="uid" use="optional"/>
      <xs:attribute name="codeSystemName" type="st" use="optional"/>
      <xs:attribute name="codeSystemVersion" type="st" use="optional"/>
      <xs:attribute name="displayName" type="st" use="optional"/>
    </xs:restriction>
  </xs:complexContent>
</xs:complexType>
</xs:schema>
```

15 Encompassing Encounter

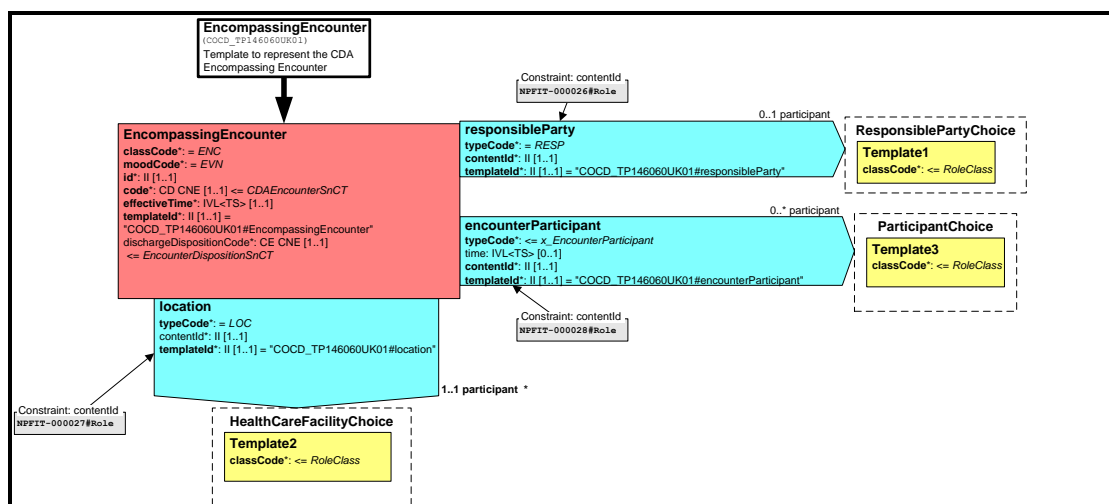

The encompassing encounter is used with some domains to add further context to the document type carried in the ClinicalDocument class.

Main uses of encompassing encounter template and associated templates.

- Type of encounter
- Type of location (CareSetting) where encounter took place
- People involved in the Encounter
- Organisations involved in the Encounter
- The actual place where the encounter happened

CDA definition

This optional class represents the setting of the clinical encounter during which the documented act(s) or ServiceEvent occurred. Documents are not necessarily generated during an encounter, such as when a clinician, in response to an abnormal lab result, attempts to contact the patient but cannot, and writes a Progress Note.

In some cases, the setting of the encounter is inherent in the ClinicalDocument.code, such as where ClinicalDocument.code is "Diabetes Clinic Progress Note". The setting of an encounter can also be transmitted in the HealthCareFacility.code attribute. If HealthCareFacility.code is sent, it should be equivalent to or further specialize the value inherent in the ClinicalDocument.code (such as where the ClinicalDocument.code is simply "Clinic Progress Note" and the value of HealthCareFacility.code is "cardiology clinic"), and shall not conflict with the value inherent in the ClinicalDocument.code, as such a conflict would constitute an ambiguous situation.

The definition of document type with HSCIC is evolving, but current definitions are that document type (ClinicalDocument.code) will contain a generic document type across domains such as "Urgent Summary Care Report" and CareSetting (HealthCareFacility.code) will contain the specialisation for the domain in question such as "Ambulance-based care".

“On the Wire” Example of Encompassing Encounter

```

<encompassingEncounter classCode="ENC" moodCode="EVN">
  <templateId root="2.16.840.1.113883.2.1.3.2.4.18.2" extension="COCD_TP146060UK01#EncompassingEncounter"/>
  <id root="C211C28D-2993-442C-A5CA-8D8461EBB23E"/>
  <code codeSystem="2.16.840.1.113883.2.1.3.2.4.15" code="11429006" displayName="Consultation"/>
  <effectiveTime value="20060928103059"/>
  <dischargeDispositionCode nullFlavor="NA"/>
  <responsibleParty typeCode="RESP">
    <templateId root="2.16.840.1.113883.2.1.3.2.4.18.2" extension="COCD_TP146060UK01#responsibleParty"/>
    <npf:contentId root="2.16.840.1.113883.2.1.3.2.4.18.16" extension="COCD_TP145022UK01#AssignedEntitySDS"/>
    <assignedEntity classCode="ASSIGNED">
      <templateId root="2.16.840.1.113883.2.1.3.2.4.18.2" extension="COCD_TP145022UK01#AssignedEntitySDS"/>
      <id root="1.2.826.0.1285.0.2.0.67" extension="100077650987"/>
      <id root="1.2.826.0.1285.0.2.0.65" extension="200009876204"/>
      <code nullFlavor="UNK"/>
      <assignedPerson determinerCode="INSTANCE" classCode="PSN">
        <templateId root="2.16.840.1.113883.2.1.3.2.4.18.2" extension="COCD_TP145022UK01#assignedPerson"/>
        <name>
          <given>Helen</given>
          <family>Marriott</family>
        </name>
      </assignedPerson>
    </assignedEntity>
  </responsibleParty>
  <location typeCode="LOC">
    <templateId root="2.16.840.1.113883.2.1.3.2.4.18.2" extension="COCD_TP146060UK01#location"/>
    <npf:contentId root="2.16.840.1.113883.2.1.3.2.4.18.16" extension="COCD_TP145024UK01#HealthCareFacility"/>
    <healthCareFacility classCode="SDLOC">
      <templateId root="2.16.840.1.113883.2.1.3.2.4.18.2" extension="COCD_TP145024UK01#HealthCareFacility"/>
      <id root="2.16.840.1.113883.2.1.3.2.4.19.1" extension="XZ901"/>
      <code code="309944008" codeSystem="2.16.840.1.113883.2.1.3.2.4.15" displayName="Obstetrics department"/>
    </healthCareFacility>
  </location>
</encompassingEncounter>

```

16 HSCIC CDA Update Semantics

The current PSIS implementation only supports replacement update semantics; therefore the current HSCIC TMS interactions only use this update semantic. ITK interactions may allow other types of update semantics and these will be documented if the need arises.

When a replacement report replaces an existing report, the parent (previous) report is considered to be superseded, but is still retained in the system for historical reference. The latest version is the clinically relevant document.

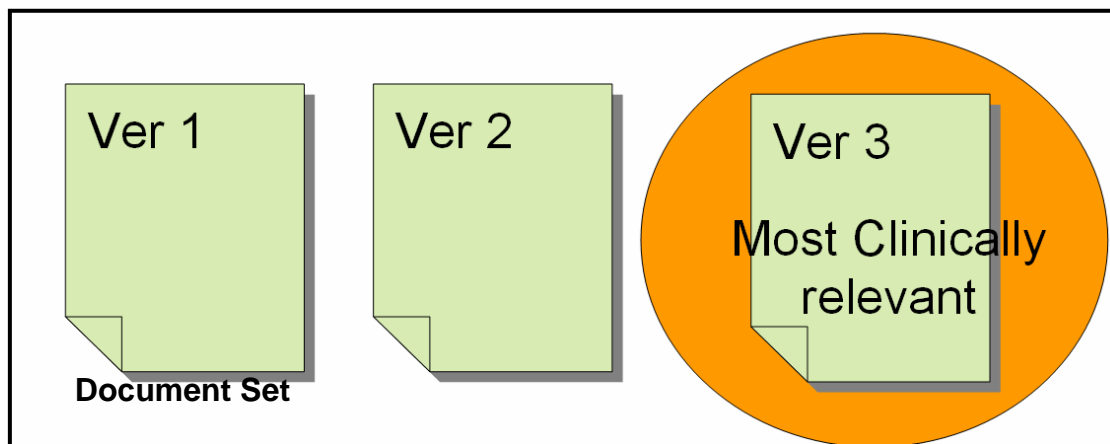

The parent (previous) report being replaced is referenced via an ActRelationship, where the ActRelationship.typeCode is set to equal "RPLC" (for "replaces") in the new report.

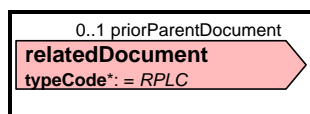

“The receiving system should replace any copy of the document stored or cached on the system on receiving a new version of a document”

***Important Note*:-** A receiving system should accept a replacement document even if it has not received the parent document. A receiving system should also replace any older version of a document from the same set with the newer version even if the parent document identified in newer version does not match the latest version held on the system. When doing document replacement after querying PSIS, there maybe a conflict in that the local version is higher than the version stored in PSIS. Where this is the case the local version should be used as the parent document version and should be incremented by one for new replacement document version number.

Illustration of update semantics when one system has an older version of the document than the one referenced within received document.

Note this functionality is currently not supported in PSIS which rejects documents that reference unknown documents for replacement but is equally relevant to point to point messaging.

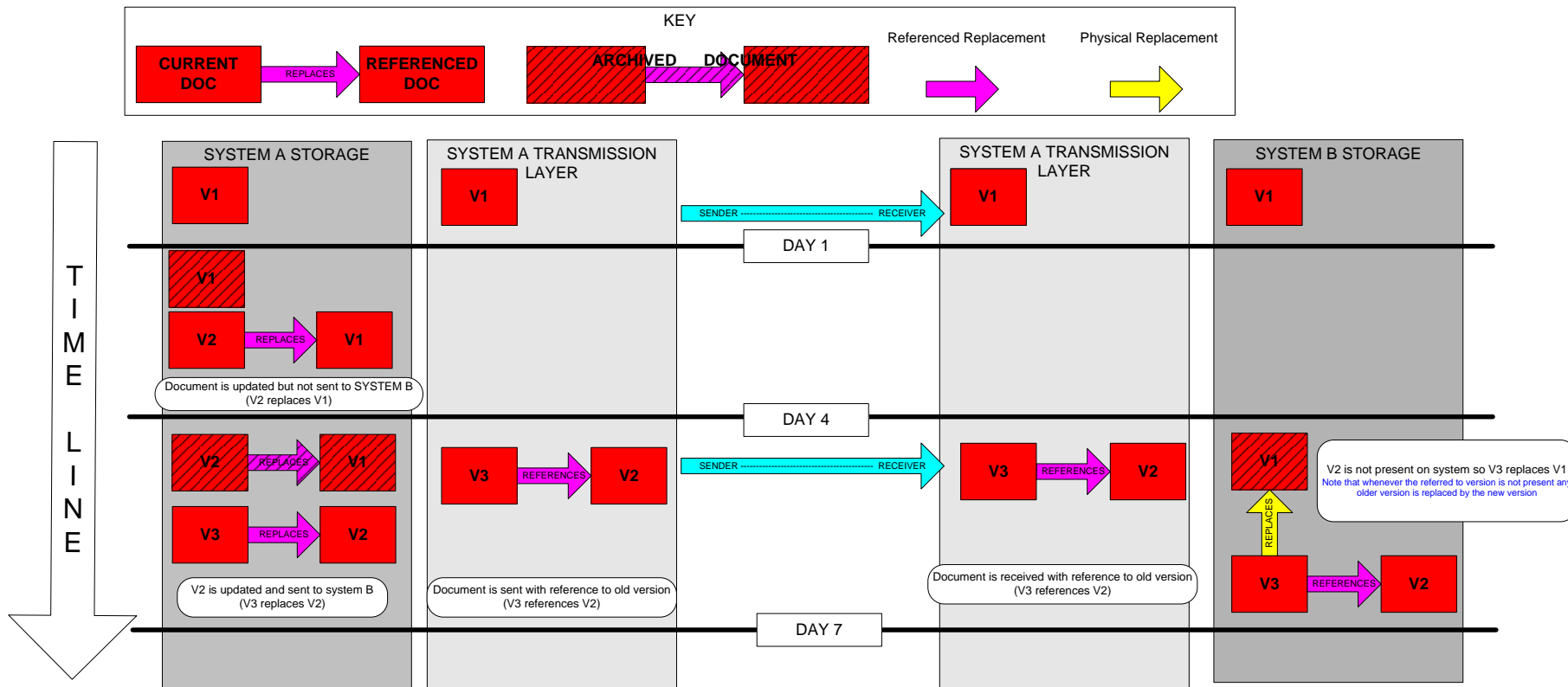

If a document is sent in error, then the sending system should send a replacement document with the correct information using standard CDA replacement update semantics. This means a new version replaces an older version. If this is not possible because no correct document is available then document nullification should be used instead. Nullification allows for a “withdrawing” type mechanism to be used with replacement. Refer to the section on [Document Nullification](#) within this specification for full details.

16.1 Class Attributes Associated With Replacement

The replacement report gets a new globally unique ID - **ClinicalDocument.id**

The replacement report uses the same setId as the parent report being replaced - **ClinicalDocument.setid** & **ParentDocument.setid**

The replacement report increments the version number by 1. - **ClinicalDocument.versionNumber**

The replacement report will reference the ParentDocument.id, ParentDocument.setid and ParentDocument.versionNumber.

16.2 ClinicalDocument.id and ParentDocument.id

These represents the globally unique instance identifiers of clinical documents. (UUIDs).

These will for example uniquely identify documents that have been stored on PSIS for all time.

The ClinicalDocument.id will identify the new clinical document and the ParentDocument.id will identify the previous document which is being replaced.

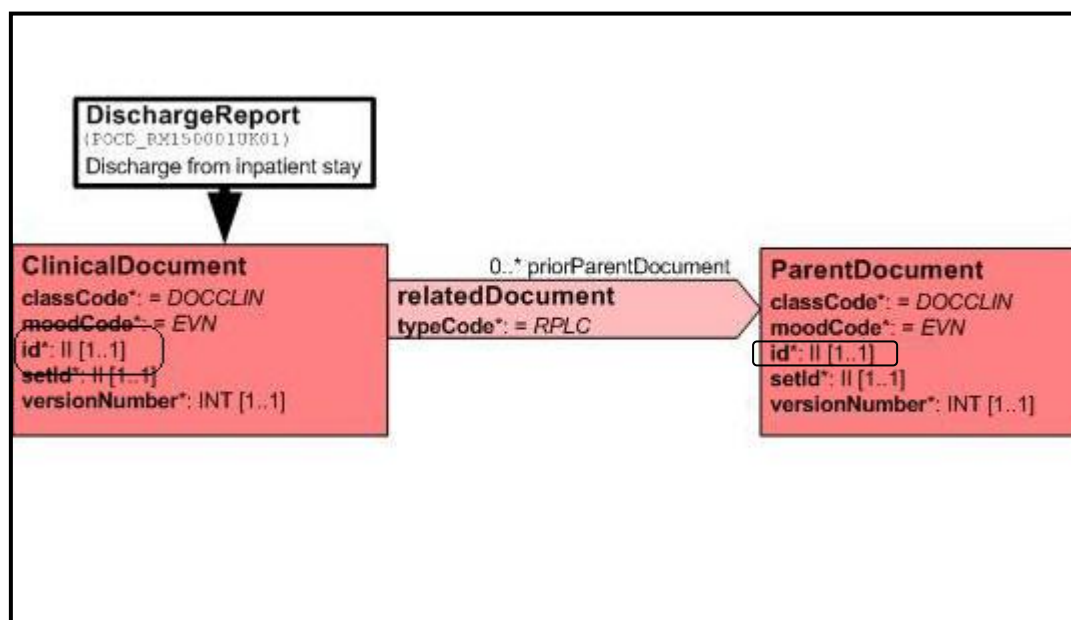

16.3 ClinicalDocument.setid and ParentDocument.setid

This represents the globally unique instance identifier of a set of clinical documents. (UUID)

The ClinicalDocument.SetId must retain the same setId as the parent document is it is replacing.

From a PSIS perspective each new version of a document replaces the previous document in the set and the set identifier will be unique for the set on PSIS for all time.

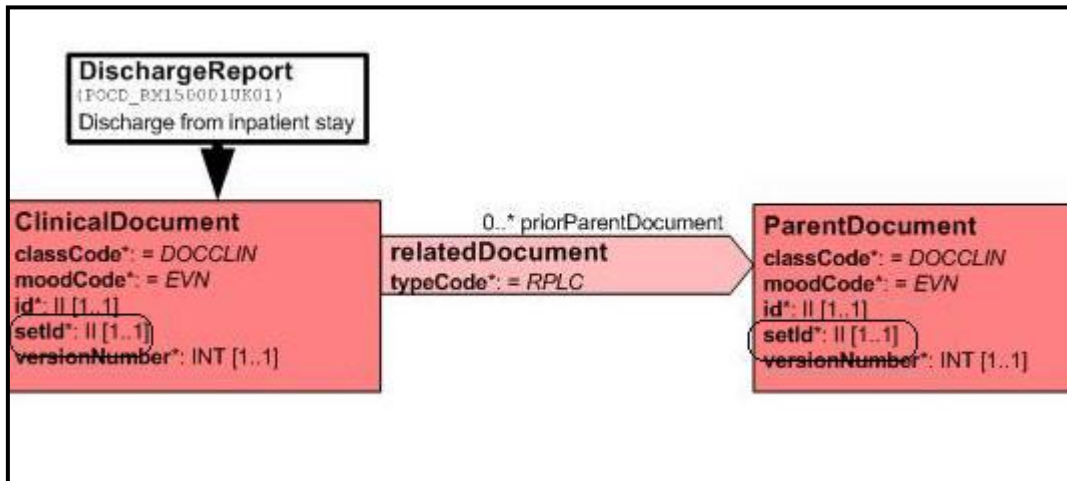

16.4 ClinicalDocument.versionNumber

This is the version number of the current document. The new version will increment the version number by one from the parent (previous) document.

This attribute uses integers (whole) numbers only - i.e. 1,2,3 1.1 etc is not allowed.

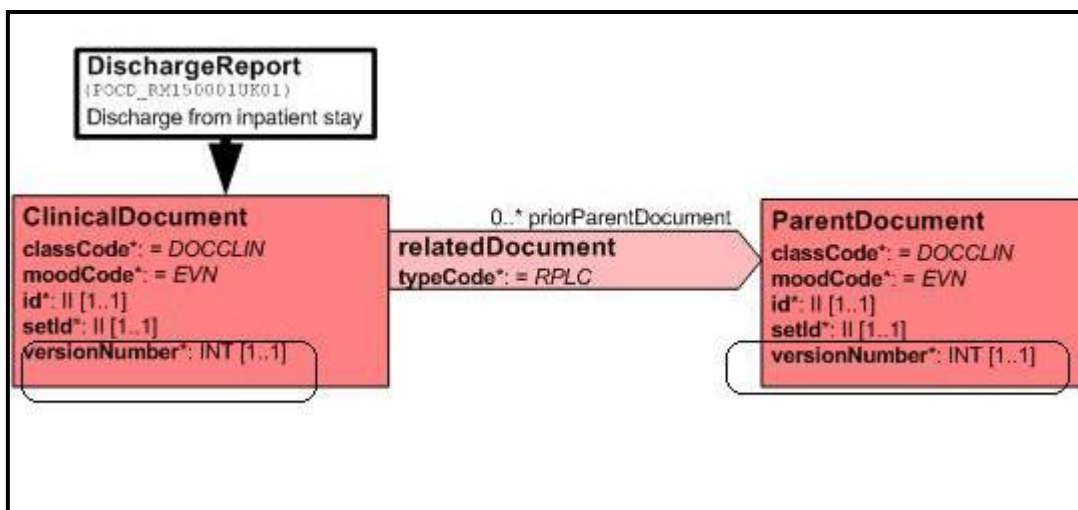

16.5 Illustration of Replacement

This diagram illustrates a possible document life cycle. It is based on the assumption that replacement will only be a single document replaced by another single document.

Note1 :- The ClinicalDocument.id, ParentDocument.id and setId will in reality be UUIDs but are simplified here for easier understanding.

Note2 :- An instance of id will be either carried in the ClinicalDocument.id or the ParentDocument.id dependant on which part of the life cycle is relevant. This is because the ClinicalDocument.id becomes the ParentDocument.id in the new version as illustrated below.

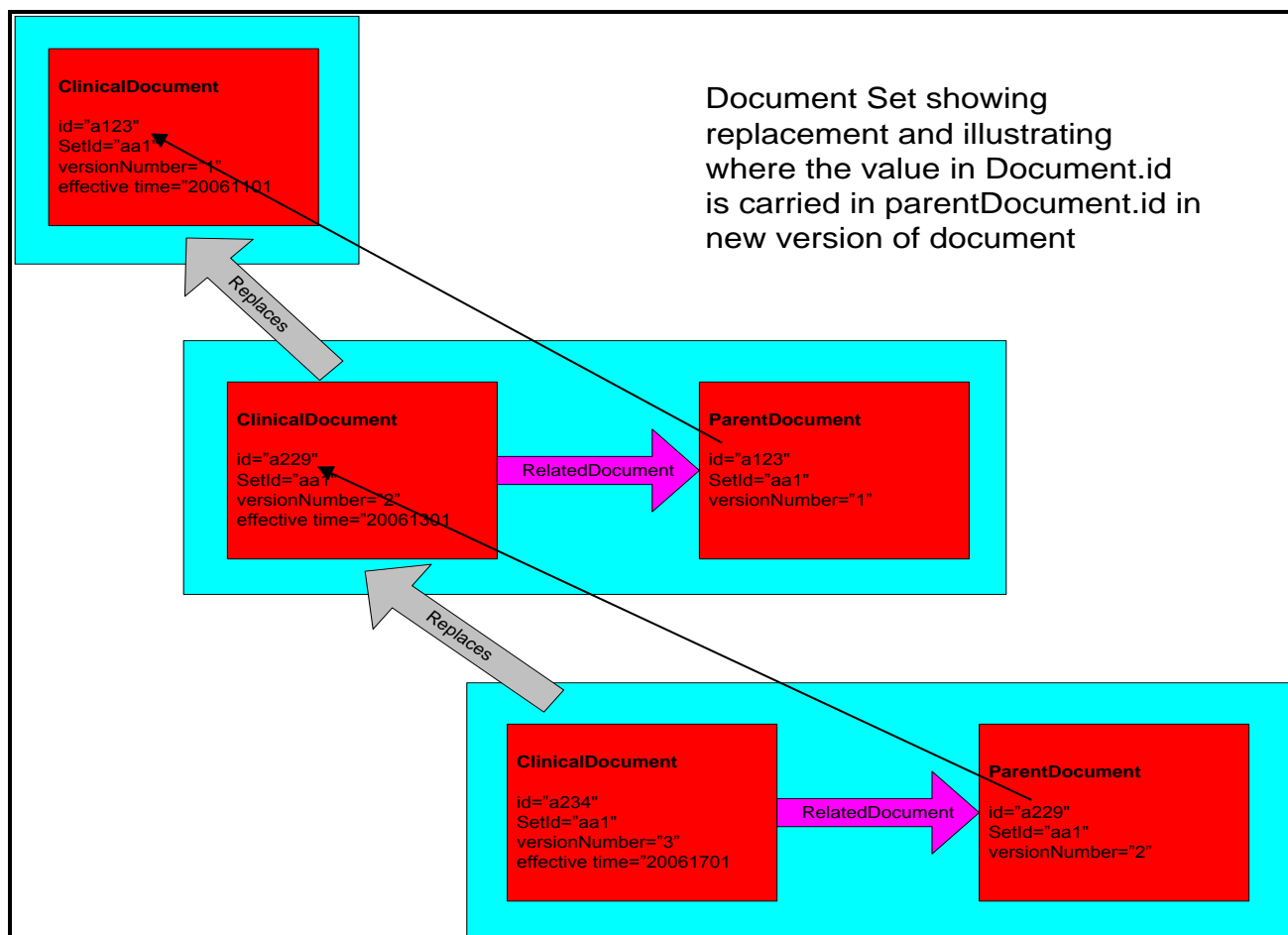

17 Document Nullification

Summary Care Record Implementation uses replacement only, although subsequent ITK interactions may use other update semantics in the future. This means that for TMS interactions there is no withdrawal mechanism as CDA does not support that type of update semantic. Instead of withdrawing a document, the TMS implementation uses replacement to nullify an incorrect document. This allows a document sent in error or containing an error, to be marked as nullified. Nullification is a separate domain within the message specification. ITK interactions can also make use of nullification if required but it is not mandated as it is for all TMS interactions

The following points apply to nullification documents

- Application Roles are defined within each domain that uses the nullification document
- Trigger Events are defined within each domain that uses the nullification document
- Interactions are defined within each domain that uses the nullification document
- There is one generic Nullification document for all HSCIC CDA domains
- The nullification document has a mandatory ParentDocument, the one that is to be nullified
- Population of DocumentId, setId ParentDocument.id and versionNumber are exactly as described for normal replacement semantics.

Note1: - Nullification documents are only used where it is not possible to use the normal replacement mechanism because no correct document is available.

Note2:- A nullification document cannot be replaced and in the event of an incorrect nullification a new document set should be started to reinstate the information contained in the previous document.

Note3:- Nullification has the usual CDA replacement semantics in that all versions previous documents in the document set are considered as nullified (replaced) and only held for audit purposes.

Note4:- Receipt of a nullification document that refers to a version not held on the receiving system should not cause an error but the system should nullify any versions of the document for the specified setId. The setId will be specified in the nullification document setId.

17.1 Illustration of Nullification

This diagram illustrates a possible document life cycle with nullification. It is based on the assumption that replacement will only be a single document replaced by another single document.

Note: - that ClinicalDocument.id , ParentDocument id and setId will in reality be UUIDs but are simplified here for easier understanding.

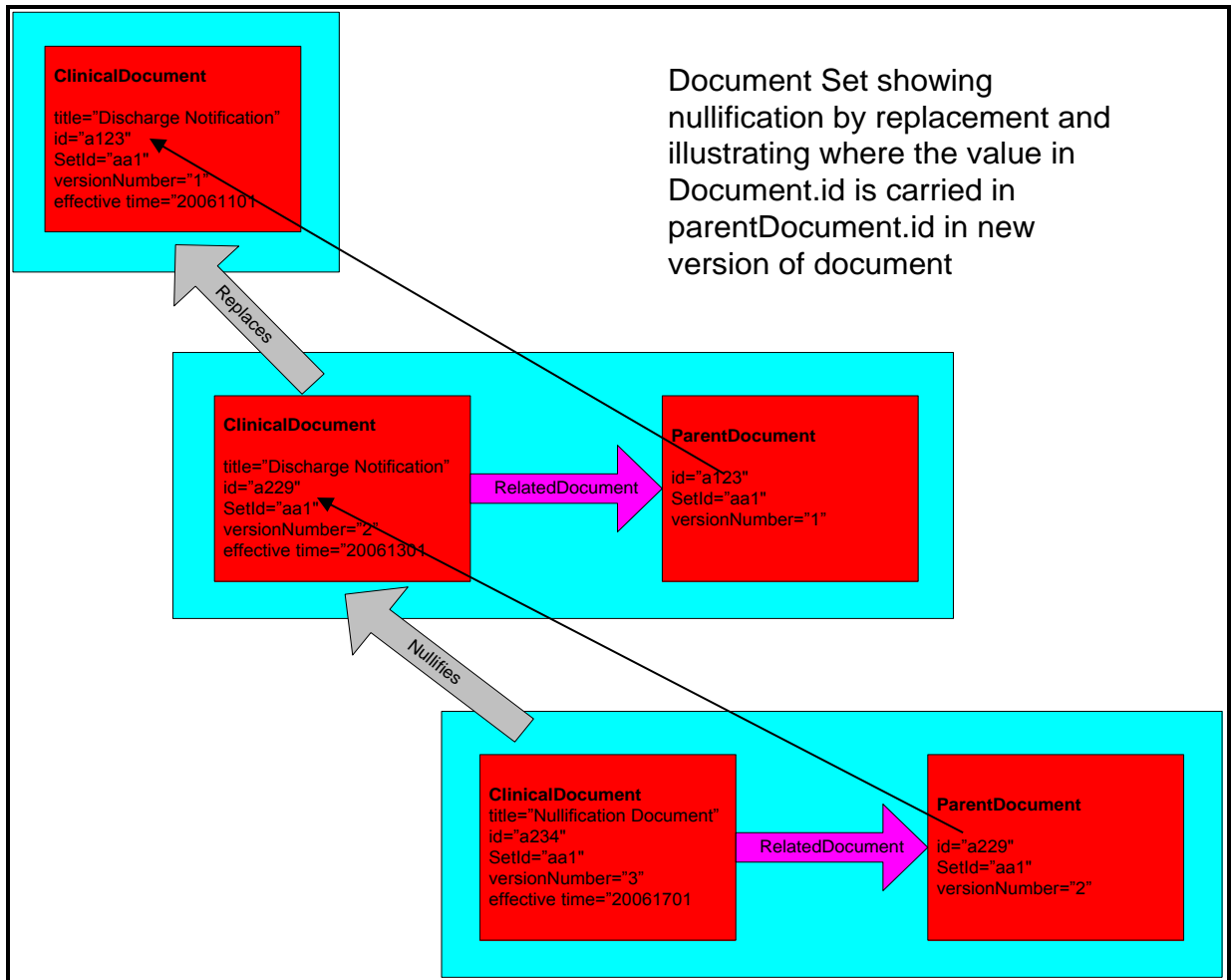

18 Use of confidentialityCode

For TMS interactions, the HSCIC CDA documents use confidentialityCode to indicate whether a document can be sealed or not. The presence of the code does NOT indicate whether a document is actually sealed but merely whether the document can be sealed. To determine whether a document is sealed the system must perform a look-up on the central access control service prior to rendering the document to the user.

Two values are used for this purpose although the HL7 x_domain x_BasicConfidentialityKind used has three values.

Code	Display Name	Definition
N	normal	Document cannot be sealed
R	restricted	NOT USED
V	very restricted	Document can be sealed

Currently confidentialityCode is not returned in PSIS queries and therefore cannot be determined without checking the actual value contained within the document. The value of the confidentialityCode is fixed in all document types and all documents types use a fixed value in the messageType attribute which is returned in the queries, therefore using the messageType attribute will enable a system to determine whether a document is capable of being sealed and whether a look up is required.

The table below shows examples of the use of messageType attribute to determine if document is capable of being sealed or not (look up required or not).

Note 1: - The central access control supports look-up by NHS number therefore it is not necessary to do a look-up for each individual document or message. The table below indicates whether a document or message can be viewed without look-up.

Document / message	messageType value	Code value	Lookup
Discharge Report	POCD_MT150001UK06	V	Yes
Emergency Department Report	POCD_MT160001UK06	V	Yes
Refusal To Seal Report	POCD_MT180001UK05	N	No
HealthSpaceSummary	POCD_MT140001UK05	N	No

For ITK interactions confidentialityCode is defined as CWE and therefore any similar coding system may be used to define confidentiality of documents. Where other coding systems are used the rules must be locally defined. The following text is taken from a universal domain profile to illustrate this.

When implementing HSCIC Sealing then:

A code from the HL7 x_BasicConfidentialityKind vocabulary to denote the level of confidentiality applied to the document.

The Coded Plain flavour of the Coded Value (CV) data type shall be used to carry this information as follows:

- The code attribute shall contain a fixed value of "V".
- The codeSystem attribute shall contain the OID of "2.16.840.1.113883.5.25".
- The displayName attribute will carry a value of "very restricted".

When this attribute contains a value of "V" ("very restricted") then the relevant centralised ACF service must be consulted prior to rendering to any user.

Otherwise it shall be populated with:

Either

A code from the HL7 x_BasicConfidentialityKind vocabulary to denote the level of confidentiality applied to the document.

The Coded Plain flavour of the Coded Value (CV) data type shall be used to carry this information as follows:

- The code attribute shall contain a value from the stated HL7 vocabulary.
- The codeSystem attribute shall contain the OID of "2.16.840.1.113883.5.25".
- The displayName attribute will carry a value associated with the code.

These codes should be populated and processed as appropriate for the local requirement for controlling access to the information.

Or

A code from an alternative vocabulary to denote the level of confidentiality applied to the document.

The Coded Plain flavour of the Coded Value (CV) data type shall be used to carry this information as follows:

- The code attribute shall contain a value from the vocabulary.
- The codeSystem attribute shall contain the OID for the vocabulary.
- The displayName attribute will carry a value associated with the code.

These codes should be populated and processed as appropriate for the local requirement for controlling access to the information.

18.1 confidentialityCode Level One validation

The confidentialityCode in the NPfIT CDA RMIM was constrained for TMS interaction use to be CNE (i.e. to use only the 3 values stated above) for use with HSCIC Sealing. The NHS CDA RMIM has removed that constraint to allow local confidentiality processes. This means that the validation of this code for the two types of interaction is done only at level 1.

The following diagrams show how this is modelled in the constrained models and the domain profile model. This also shows how important the two stage validation is.

NPfIT CDA RMIM

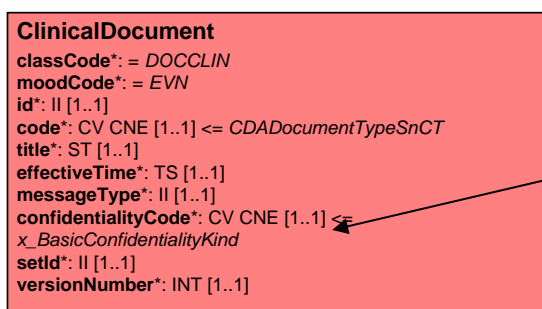

Only the stated vocabulary domain can be

NHS CDA RMIM

```

ClinicalDocument
classCode* = DOCCLIN
moodCode* = EVN
id*: II [1..1]
code*: CV CNE [1..1] <= CDADocumentTypeSnCT
title*: ST [1..1]
effectiveTime*: TS [1..1]
messageType*: II [1..1]
confidentialityCode*: CV CWE [1..1] <=
x_BasicConfidentialityKind
setId*: II [1..1]
versionNumber*: INT [1..1]
    
```

Any vocabulary may be used and the default is the stated vocabulary domain can be

Domain model

```

ClinicalDocument
classCode* = DOCCLIN
moodCode* = EVN
id*: II [1..1]
code*: CV CNE [1..1] <= CDADocumentTypeSnCT
title*: ST [1..1]
effectiveTime*: TS [1..1]
messageType*: II [1..1]
confidentialityCode*: CV CWE [1..1] <=
x_BasicConfidentialityKind
setId*: II [1..1]
versionNumber*: INT [1..1]
    
```

Any vocabulary may be used and the default is the stated vocabulary domain can be

PASS or FAIL in red means it would pass or fail but in reality is never tested

"On wire instance"	LEVEL 1		LEVEL 2
	NPfIT CDA RMIM	NHS CDA RMIM	Domain Profile
TMS interaction with correct code	PASS	PASS	PASS
TMS interaction with incorrect code	FAIL	PASS	PASS
ITK interaction with any code	FAIL	PASS	PASS

19 SNOMED CT subsets and templates

The following section details the use of SNOMED CT subsets with the HSCIC templates.

19.1 SNOMED CT Subsets within Templates

The templates use SNOMED CT subsets to constraint the allowed values from SNOMED CT to a suitable set.

Note:- Most SNOMED CT subsets are used in templates, but subsets can used within other classes in the HSCIC CDA documents, Currently the only example is the ClinicalDocument class which uses a subset to indicate the type of document.

The subsets are defined in the TRUD and can be updated on release of a new version of SNOMED CT. This enables codes to be added or removed as required without the need to change the vocabularies or re-issue the message specification.

The subsets are allocated a subset id and this id is specified with the vocabulary.

In some case there maybe be several subset ids specified within a single vocabulary. This gives greater flexibility and more re-usability of templates.

Guidance on the correct subset to use in a given situation may be issued on domain basis.

19.2 Example of subset representation with a vocabulary

Example vocabulary, exact format may vary dependant on usage rules.

Note:- subset ids are for illustration only

Vocabulary for AdministrativeProcedureTypeSnCT

Code System Id

2.16.840.1.113883.2.1.3.2.4.15

Version:	2.0
Status:	active
Date:	2007-04-16

Description

A subset of the SNOMED-CT clinical terminology (i.e. coding system) intended for use in the UK, previously named SNOMED CTUK, which describes an administrative procedure.

Any code from the SNOMED CT UK *Administrative Procedure* subset for the relevant domain

Domain	Subset id
Discharge	1051000000130
Admission	1051099000120
HSCI	1051099000140
	1051099000150
	1051099000160

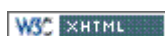

This page conforms to the W3C XHTML 1.0 Recommendation.

19.3 Subset Conformance within Templates

Subsets used in templates have two types of conformance.

1. Mandated
2. Advisory

Mandated

Extract from Tabular view - "*The members of this subset must be used*"

No codes outside of the subset are allowed to be used with the template.

If a code is to be messaged which is not contained in the mandatory subset then:

- A more generic template should be used where appropriate. This will potentially remove the mandated subset constraint and therefore allow the concept to be messaged.
- Use free text where a more generic template is not appropriate
- Request extension of the subset where appropriate.

Advisory

Extract from tabular view - *“Codes outside this subset may be used at clinical discretion. There may be codes in the subset which are unsuitable”*.

- Advisory subsets contain most of the codes required but there will be cases when codes are required that are not contained within the subset. It is allowable therefore to use these codes with the template when there is a clinical requirement to do so.

These rules are no longer stated in the tabular views and each subset has its conformance stated in the vocabulary. Where a template uses a fixed code no conformance will be stated in the vocabulary.

Note where a vocabulary has no conformance stated it then defaults to advisory.

20 Text Section Template

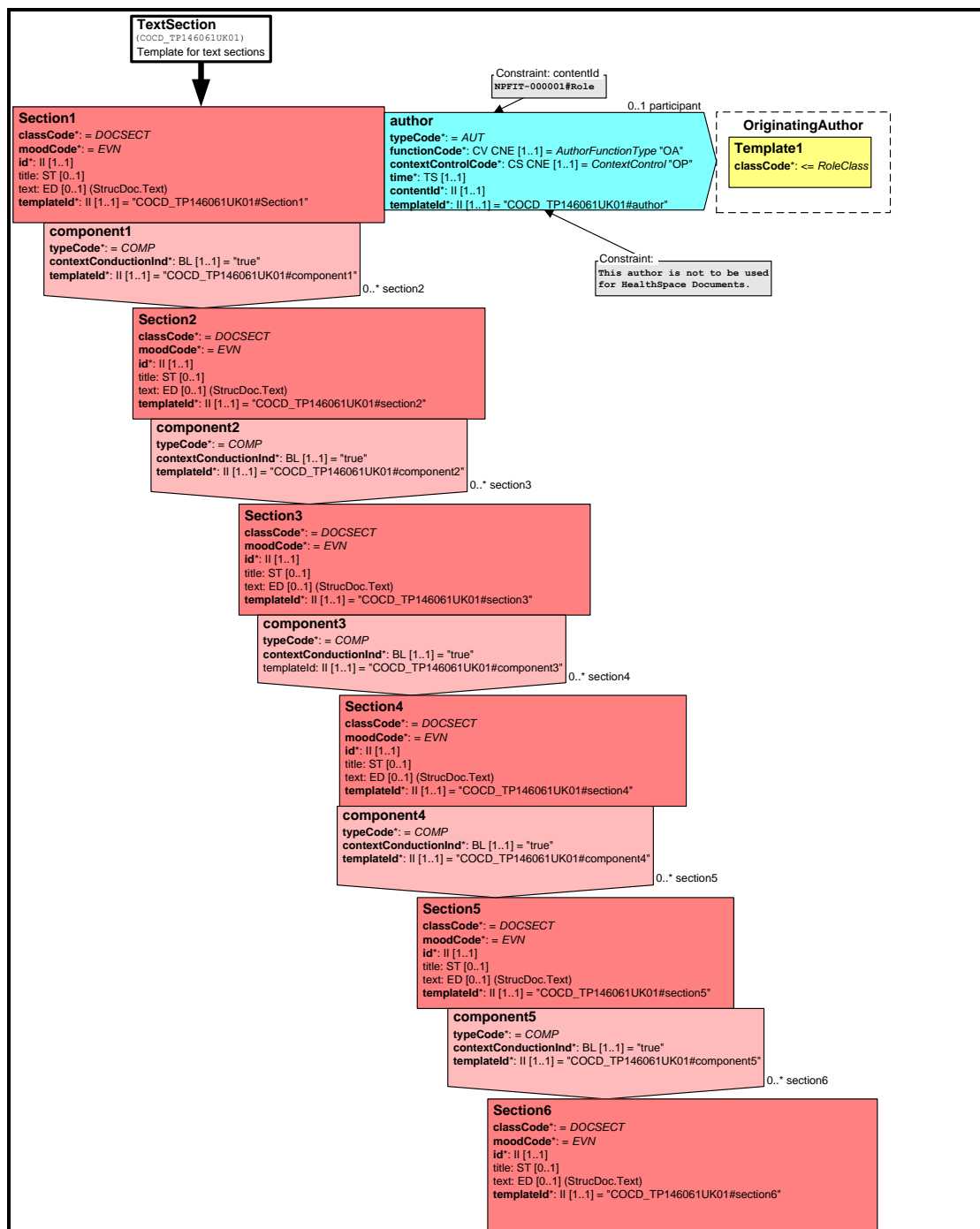

A single text section template is used across all domains for consistency and ease of use with the templating mechanism. Previous document versions used separate text templates for each domain which was over complicated and high maintenance.

Using one text section template it is not possible to have separate text sections for text linked to coded entries and unlinked text. This would also break up the natural narrative flow of the document and cause possible rendering issues as the CDA default renderer renders text in the order it appears in the document and therefore this has not been supported.

The text template has 6 nested sections with option title and text fields. This allows the nesting to be representative of html "h1" to "h6" when rendering the document. The title attribute allows the use of "soft headings" throughout the document. The term "soft headings" is used to indicate that the headings are not imposed by the RMIM structure (hard coded) as previously modelled in the early HSCIC CDA documents when CRE Types were implemented using the title attribute in an organiser. The intention now has been to provide for flexibility in the presentation of text for the foreseeable future, whilst imposing sufficient constraint on the structure to enable straightforward rendering

The text section template has an author only on the top level (first in the model) text section. The “rationale” here was that normally if there was a different author than the inherited author there would normally be a new high level section within the document. This template does still support different authors at any level by making use of HL7 context conduction (inheritance).

20.1 Specialised Text Sections

Some domains have special templates for the text sections which can enforce a much more structured format. These templates can mandate such things as headings and text under headings to have specific value or content. The models for these templates tend to be much larger and complex but they do produce a very tight schema for conformance. In the example below each individual section is a separate class with a fixed title.

Example of a specialised text section template.

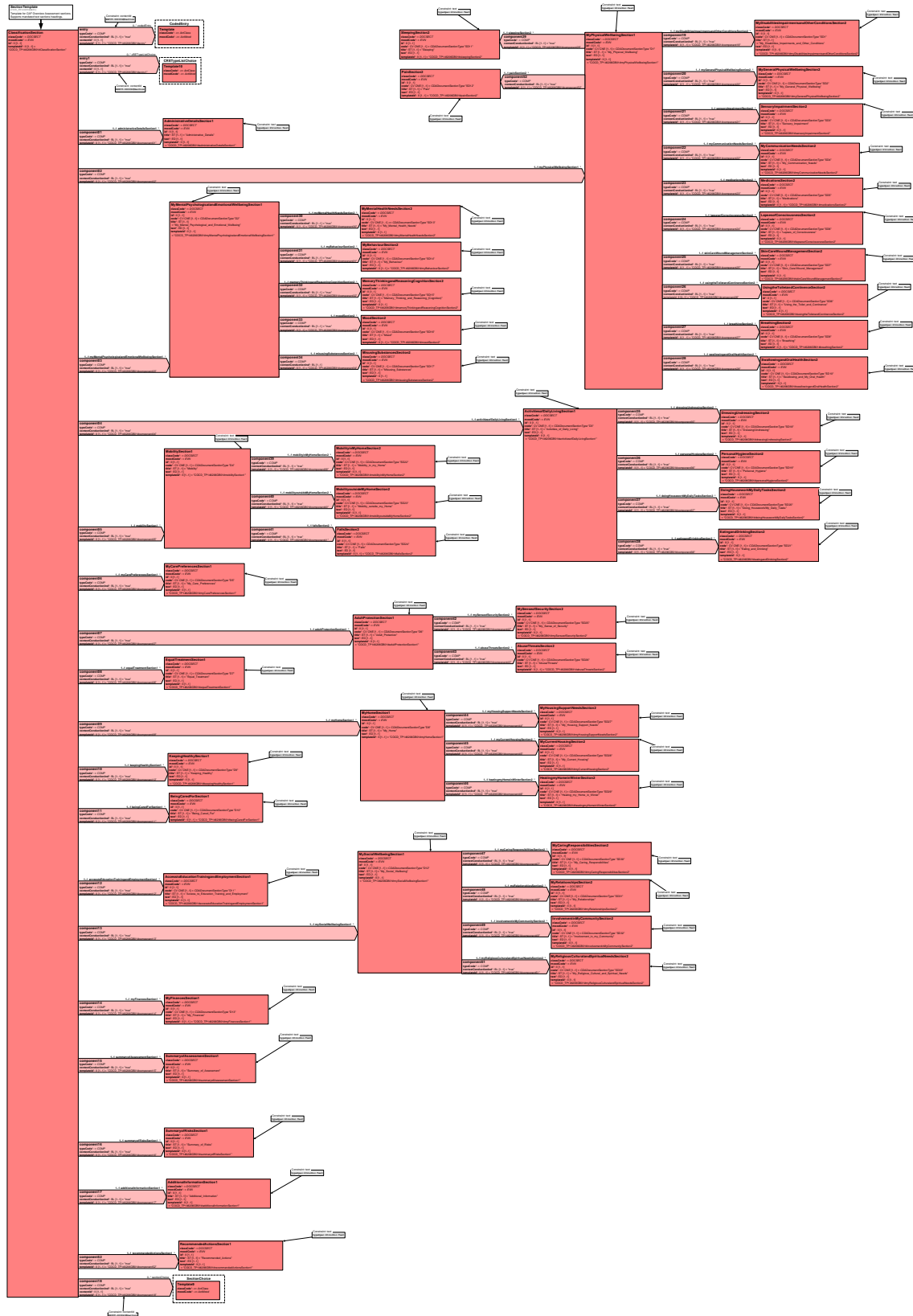

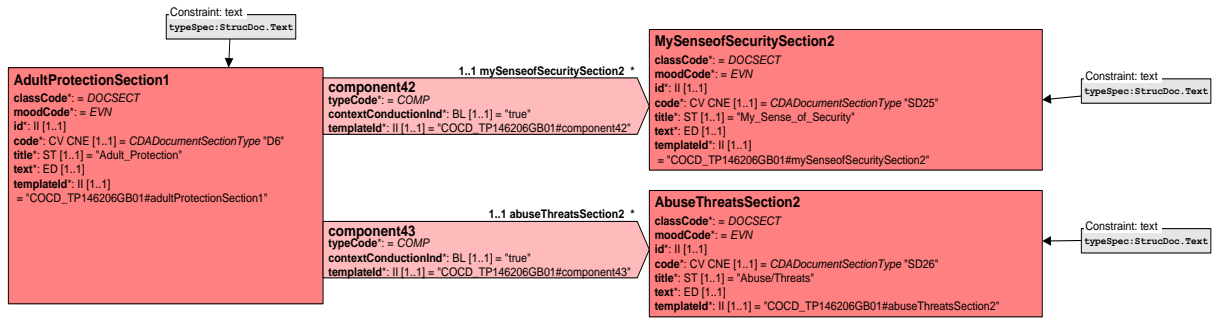

20.2 Representation of author inheritance within text sections

This diagram illustrates that although author is not modelled on all sections it is inherited to all sections. The author of section1 is also the author of all following sections.

Note:- The Inherited Authors are only shown for clarity and this illustration does not represent the actual RMIM

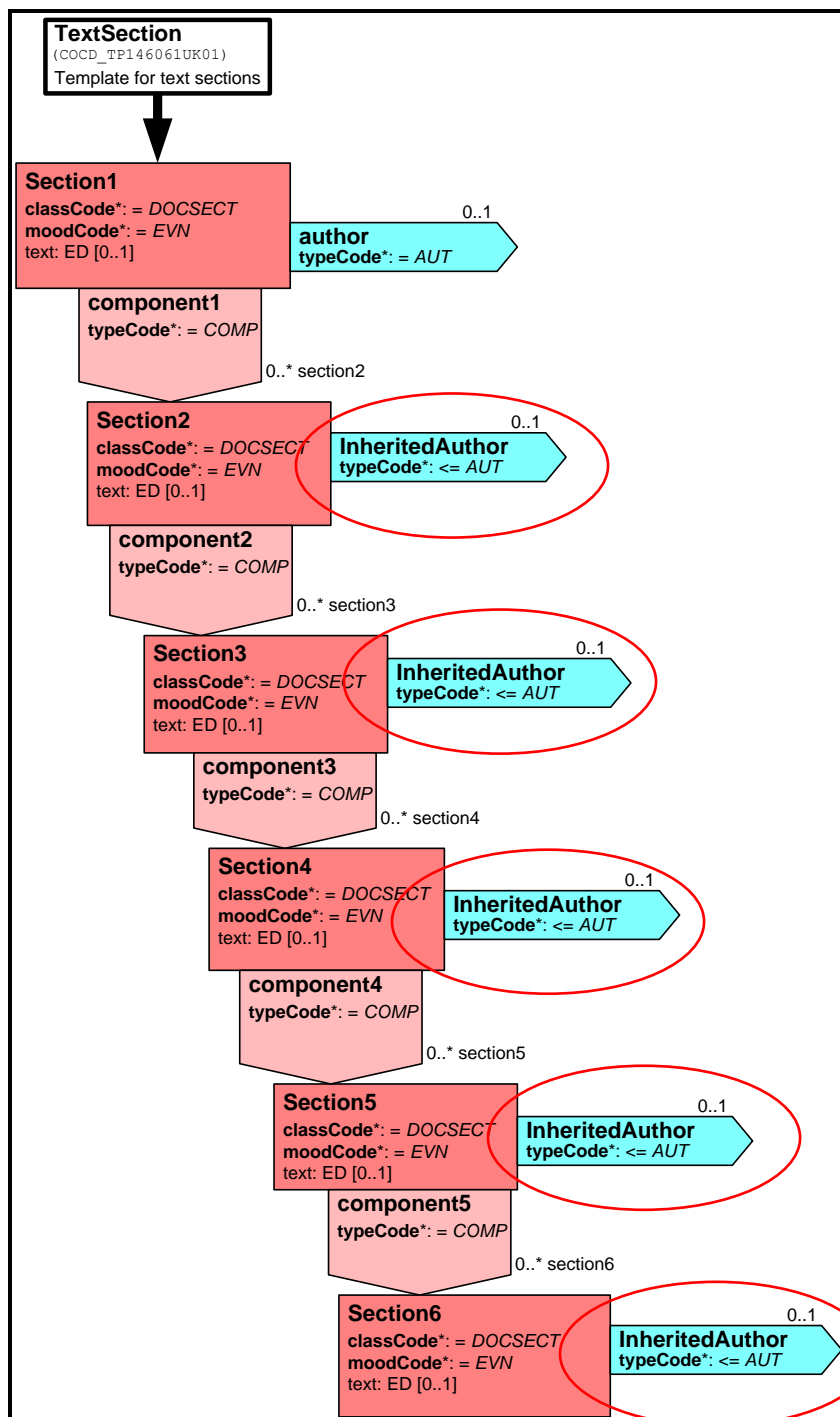

20.3 Representing new authors within nested text sections

The illustration below, shows a representation of author when new author required at level 4, this method is used when a different author is required without changing the nesting structure

within a document, for example when a document has sections at level 4 and requires a different author but also requires that the different authored information is rendered at level 4. The new author is always added at level 1 and inherited to the section which contains the text that has been authored by the new author.

Note1: - The three preceding sections have no text attribute in the section and therefore do not appear in the rendered text.

Note2:- The Inherited Authors are only shown for clarity and this illustration does not represent the actual RMIM.

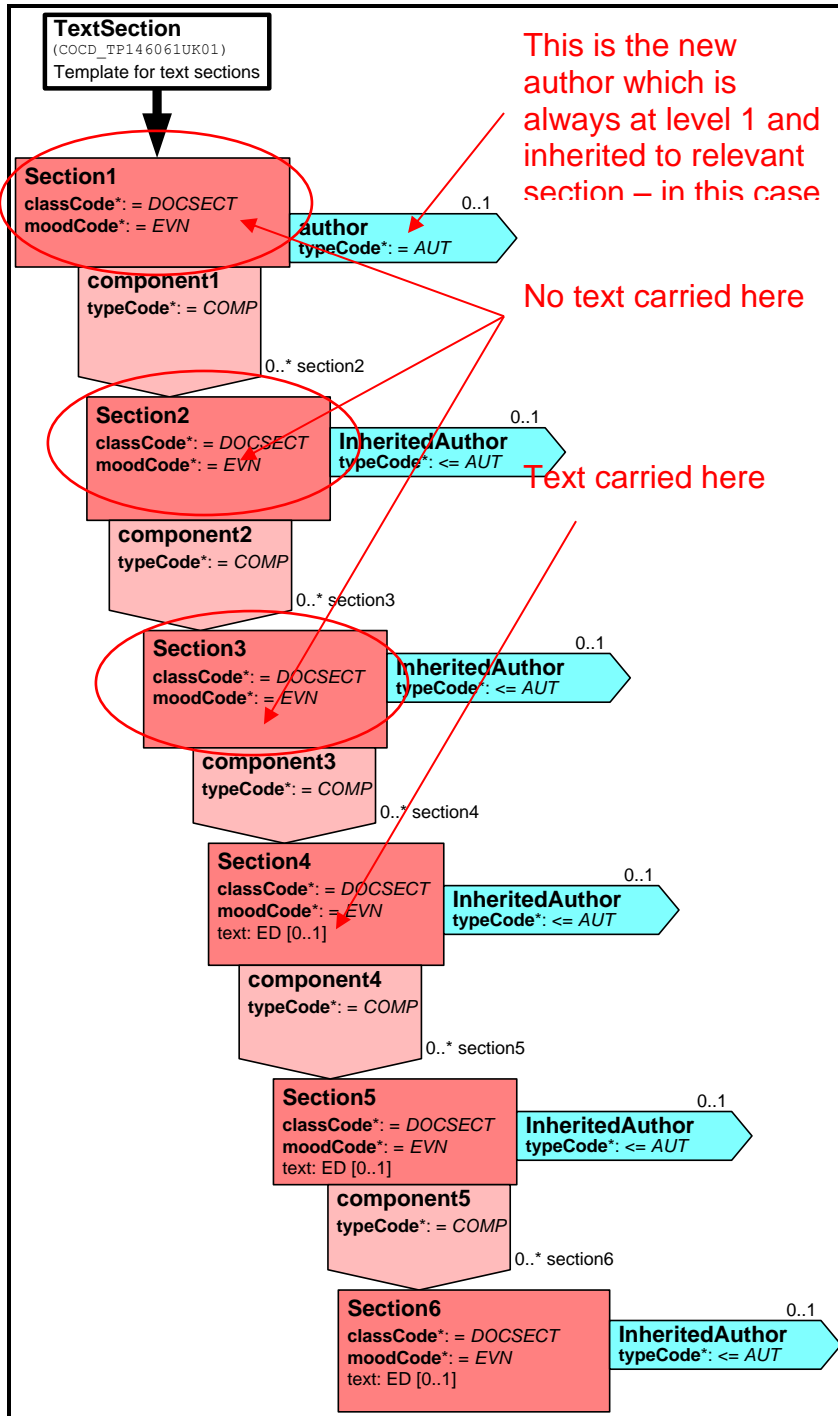

20.4 Example of nested author representation

“On the wire” Example fragment of a new author at level 4 text section.

```
<?xml version="1.0" encoding="UTF-8"?>
<component typeCode="COMP" contextConductionInd="true">
  <npfict:contentId root="2.16.840.1.113883.2.1.3.2.4.18.16" extension="COCD_TP146061UK01#Section1"/>
  <section classCode="DOCSECT" moodCode="EVN">
    <templated root="2.16.840.1.113883.2.1.3.2.4.18.2" extension="COCD_TP146061UK01#Section1"/>
    <id root="D92DCC40-EF24-11DB-A1A6-F5CA408FF127"/>
    <author typeCode="AUT" contextControlCode="OP">
      <npfict:contentId root="2.16.840.1.113883.2.1.3.2.4.18.16" extension="COCD_TP145001UK03#AssignedAuthorSDS"/>
      <functionCode code="OA" codeSystem="2.16.840.1.113883.2.1.3.2.4.17.178" displayName="Originating Author"/>
      <time value="200608271807"/>
      <assignedAuthor classCode="ASSIGNED">
        <templated root="2.16.840.1.113883.2.1.3.2.4.18.2" extension="COCD_TP145001UK03#AssignedAuthorSDS"/>
        <id root="1.2.826.0.1285.0.2.0.65" extension="100099876439"/>
        <id root="1.2.826.0.1285.0.2.0.67" extension="200025166218"/>
        <code code="R0620" codeSystem="2.16.840.1.113883.2.1.3.2.4.17.196" displayName="Staff Nurse"/>
        <assignedPerson classCode="PSN" determinerCode="INSTANCE">
          <templated root="2.16.840.1.113883.2.1.3.2.4.18.2" extension="COCD_TP145001UK03#assignedPerson"/>
          <name>
            <prefix>Ms.</prefix>
            <given>Natalie</given>
            <family>Wallace</family>
          </name>
          </assignedPerson>
          <representedOrganization classCode="ORG" determinerCode="INSTANCE">
            <templated root="2.16.840.1.113883.2.1.3.2.4.18.2" extension="COCD_TP145001UK03#representedOrganization"/>
            <id root="2.16.840.1.113883.2.1.3.2.4.19.2" extension="XZ901"/>
            <name>St. Elsewhere's Hospital</name>
          </representedOrganization>
        </assignedAuthor>
      </author>
    <component typeCode="COMP" contextConductionInd="true">
      <templated root="2.16.840.1.113883.2.1.3.2.4.18.2" extension="COCD_TP146061UK01#component2"/>
      <section classCode="DOCSECT" moodCode="EVN">
        <templated root="2.16.840.1.113883.2.1.3.2.4.18.2" extension="COCD_TP146061UK01#section2"/>
        <id root="D92DCC40-EF24-11DB-A1A6-F5CA408FF127"/>
        <component typeCode="COMP" contextConductionInd="true">
          <templated root="2.16.840.1.113883.2.1.3.2.4.18.2" extension="COCD_TP146061UK01#component3"/>
          <section classCode="DOCSECT" moodCode="EVN">
            <templated root="2.16.840.1.113883.2.1.3.2.4.18.2" extension="COCD_TP146061UK01#section3"/>
            <id root="D92DCC40-EF24-11DB-A1A7-F5CA408FF127"/>
            <component typeCode="COMP" contextConductionInd="true">
              <section classCode="DOCSECT" moodCode="EVN">
                <templated root="2.16.840.1.113883.2.1.3.2.4.18.2" extension="COCD_TP146061UK01#section4"/>
                <id root="D92DCC40-EF24-11DB-A1A8-F5CA408FF127"/>
                <title>Findings on examination</title>
                <text>
                  <list listType="ordered">
                    <item>Supra pubic and back pain</item>
                    <item>Bleeding PV</item>
                    <item>Normal vital signs</item>
                  </list>
                </text>
              </section>
            </component>
          </section>
        </component>
      </section>
    </component>
  </section>
</component>
```

20.5 Text Sections with Codes

It should be noted that in MIM 6.3.01 the HSCIC CDA domains (Emergency, Discharge and Outpatients) have no business requirement to identify sections of narrative text by classifying the section using section.code. However, MIM 7.2.00 has Health and Social Care Integration and Diagnostic Imaging domains where there is such a business requirement. Vendors should be aware of this when designing systems and develop solutions which will support both constraints of the NPfIT CDA generic model as published in MIM 6.3.01 and MIM 7.2.00 . Usage of text section code is demonstrated in the examples of the aforementioned domains within MIM 7.2.00. and the following section.

The text section with code template tabular view carries the following text

Use of this code attribute has the following constraints

- The *code* SHALL contain a value from the code list specified within the vocabulary for use with the domain
- The *codeSystem* SHALL contain the OID specified within the vocabulary for use with the domain
- The use of *displayName* may be optional, mandatory or prohibited dependant on domain usage
- The guidance documentation for the relevant domain SHALL provide guidance on use of these attributes
- Where NO guidance is given on the use of these attributes by the domain's documentation, then use of these attributes is prohibited.

The code list for this attribute is held in separate sub vocabularies within the CDADocumentSectionType vocabulary as illustrated in example below.

Vocabulary for CDADocumentSectionType

Code System Id

2.16.840.1.113883.2.1.3.2.4.17.223

Version:	3.0
Status:	active
Date:	2007-12-20

Description

A set of codes to identify the document section type.

Individual domains may specify the codes to use as follows:

- For HSCI Overview Assessment Document codes from the vocabulary [CAInformationSet](#) (OID=2.16.840.1.113883.2.1.3.2.4.17.222) should be used.
- For Diagnostic Imaging Report codes from the vocabulary [DICDADocumentSectionType](#) (OID=2.16.840.1.113883.2.1.3.2.4.17.243) should be used.
- For Integrated Care and Support Plan document codes from the vocabulary [TextHeadingType](#) (OID=2.16.840.1.113883.2.1.3.2.4.17.225) should be used.

This page conforms to the W3C XHTML 1.0 Recommendation.



Please refer to the generic CDA R2 2005 Normative Edition documentation as published by HL7 for details of the section.code attribute.

20.6 Use of text section code in Health and Social Care Integration

All Health and Social Care Integration documents as in MIM 7.2.00 use the coded text section template, therefore allowing use of a code to identify a text section or sections. At the time of publication of this document, there is only a business use case for the Overview Assessment and the Integrated Care and Support Plan to use a code in the text section.

Reasons for using coded text sections in HSCI

- There is a requirement to enable there to be a mechanism where a common format HSCIC CDA document could be derived from output generated by various assessment tools, therefore allowing better interoperability between the various different HSCI systems

This section does not define where to use a coded text section or whether it is mandated within this domain but merely gives illustration to how it may be used. Therefore, this section should be read in conjunction with the latest conformance documentation for Health and Social Care Integration domain.

Which systems use coded text section.

- The code attribute is used by HSCI compliant systems when constructing the HSCIC CDA documents
- All other systems when viewing documents should just render the documents using standard rendering

20.7 CAF Information set code usage

This vocab consists of 3 levels of classification. The 7 Outcomes for adults come from the white paper Our Health, Our Care, Our Say. These have then been broken down into groups of domains, which breakdown further into sub-domains. This vocab is consistent with version 2.0 of the CAF information set produced by the Department of Health

The codes contained in the CAF Information Set vocabulary are also used in the ID attribute within the narrative block text (html) of the HSCIC CDA document. The use of ID with the CAF Information Set codes is documented in the use of the ID attribute section.

Example XML fragment indicating a table classified as D4 – “Mobility” in an Overview Assessment. In this example, the title attribute also contains mobility but this may not be always

be the case. It could be “Getting Around” for example. The code allows machine identification and processing of the text section and the title field allows a local text string for rendering.

```

<section moodCode="EVN" classCode="DOCSECT">
<templateId root="2.16.840.1.113883.2.1.3.2.4.18.2"
extension="COCD_TP146061UK02#Section1"/>
<id root="7D5E5B00-AE1A-11DB-96C4-B18E1E0994CD"/>
<code code="D4" codeSystem="2.16.840.1.113883.2.1.3.2.4.17.222"/>
<title>Mobility</title>
  <text>
    <table width="100%">
      <tbody>
        <tr>
          <td colspan="2" align="center">
<content styleCode="Bold">Mobility</content>
          <paragraph>Outcome ? Improved Personal Dignity and Autonomy
        </td>
      </tr>
    </tbody>
  </table>
</text>
</section>
    
```

Illustration of Text Section Code Usage in HSCI domain

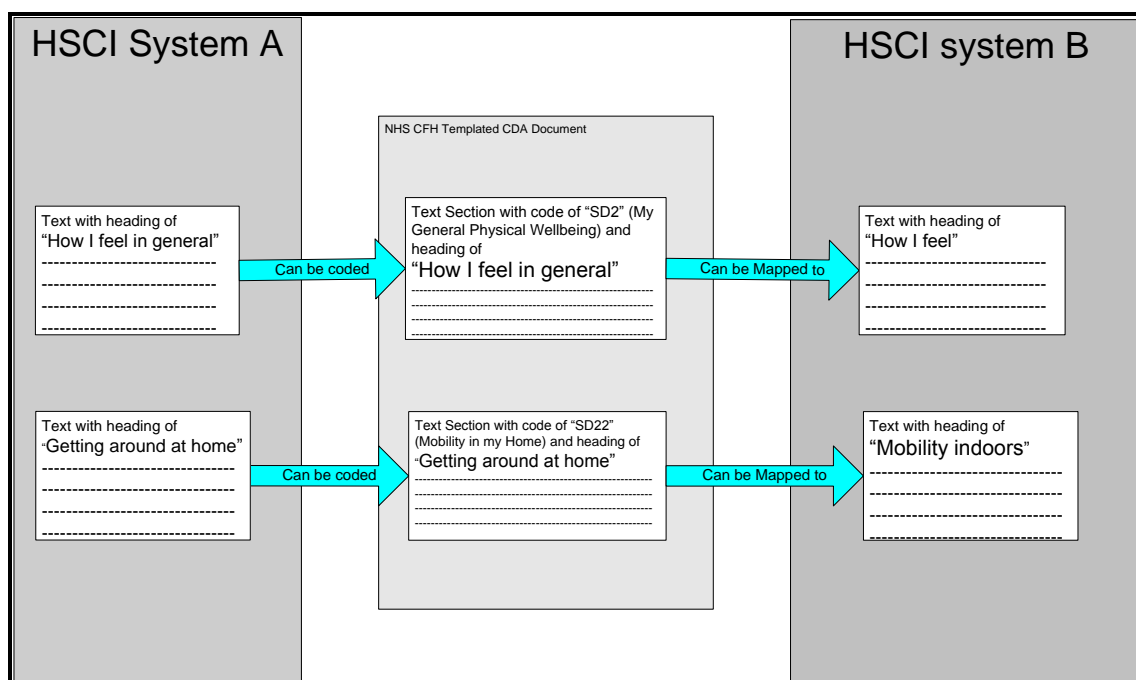

20.7.1 TextHeadingType code usage 1

A list of codes used to classify text under certain headings in a document for machine identification and processing

Example XML fragment indicating text classified as GD – “Goal Details” in an Integrated Care and Support Plan. In this example, the title attribute contains “Care Plan Goals” but this it can still be identified as Goal Details. The code allows machine identification and processing of the text section and the title field allows a local text string for rendering.

```
<section moodCode="EVN" classCode="DOCSECT">
<templateId root="2.16.840.1.113883.2.1.3.2.4.18.2"
extension="COCD_TP146061UK02#Section1"/>
<id root="7D5FE1A0-AE1A-11DB-96DA-B18E1E0994CD"/>
<code code="GD" codeSystem="2.16.840.1.113883.2.1.3.2.4.17.225"/>
<title>Care Plan Goals</title>
  <text>
    <paragraph>
      <content ID="a2">
        Independence with personal care activities and mobility
      </content>
    </paragraph>
  </text>
</section>
```

20.7.2 TextHeadingType code usage 2

A list of codes used to classify text under certain headings in a document for machine identification and processing

The list of codes is used in the TextHeadingType class value attribute and links to a content ID attribute within the native block text (html) of the HSCIC CDA document using the standard CDA referencing mechanism detailed in the relevant section in this document.

Example XML fragments indicating text classified as SUM – “Summary Details” in an Integrated Care and Support Plan using the code attribute in value. In this example the TextHeadingType value.originalText.reference.value attribute contains a reference of #a1 which links to text enclosed content ID of a1 in the referred to paragraph of text The code and content ID linking mechanism allows machine identification and processing of the text section at paragraph, word, phase etc level. This also means that a text section can be broken down in multiple sub-sections with or without sub-headings (* soft headings) as required.

Note: - * A soft heading is a heading NOT contained in a title attribute but only in the text and is therefore rendered as marked up in the document. (i.e. Bold, Italic etc). The usage of soft heading is dependent on domain conformance rules.

```

<entryRelationship typeCode="COMP" contextConductionInd="true">
  <templateId root="2.16.840.1.113883.2.1.3.2.4.18.2" extension="COCD_TP146075UK02#entryRelationship1"/>
  <seperatableInd value="false"/>
  <observation moodCode="EVN" classCode="OBS">
    <templateId root="2.16.840.1.113883.2.1.3.2.4.18.2" extension="COCD_TP146075UK02#textHeadingType"/>
    <code codeSystem="2.16.840.1.113883.2.1.3.2.4.17.220" code="THT" displayName="Text Heading Type"/>
    <value xsi:type="CV.NPHT.CDA.Uri" code="SUM" codeSystem="2.16.840.1.113883.2.1.3.2.4.17.225" displayName="Summary Details">
      <originalText>
        <reference value="#a1"/>
      </originalText>
    </value>
  </observation>
</entryRelationship>
    
```

```

<text>
  <paragraph>
    <content ID="a1">Walters sustained a hip fracture and a fractured shoulder 6 months ago following a road traffic accident and has not made a full recovery. She is having difficulties with mobilising and carrying out personal care and dressing tasks. Personal care is being provided and rehab services to help Ms Walters to improve ADLs and mobility, with a review planned in 8 weeks.
    </content>
  </paragraph>
</text>
    
```

20.8 Use of Text Section Code in Diagnostic Imaging Domain

The codes available to classify Diagnostic Imaging text sections are contained in the DICDADocumentSectionType vocabulary. These allow identification of text sections that are for example "Recommendations"

This section does not define where to use a coded text section or whether it is mandated within this domain but merely gives illustration to how it may be used. Therefore this section MUST be read in conjunction with the latest conformance documentation for Diagnostic Imaging domain.

How do systems use coded text section?

- The code attribute is used by Diagnostic Imaging systems when constructing the HSCIC CDA documents
- Diagnostic Imaging systems may make use of the code attribute on receipt of a Diagnostic Imaging document from another system if so desired.
- All other systems when viewing documents should just render the documents using standard rendering rules

Example of text section code usage in Diagnostic Imaging. This example shows the use of code to identify the section as a finding section.

```

<section classCode="DOCSECT" moodCode="EVN">
  <templateId root="2.16.840.1.113883.2.1.3.2.4.18.2" extension="COCD_TP146061UK02#Section1"/>
  <id root="247AF3C3-1B6A-47C5-8E33-07A430AF47E8"/>
  <code code="DI12" codeSystem="2.16.840.1.113883.2.1.3.2.4.17.243"/>
  <title>Ultrasound Renal Report</title>
  <text>The right kidney is normal. The left kidney is enlarged and shows moderate hydronephrosis. There debris within the pelvi-calyceal system. The upper ureter is dilated. The appearances are consistant with obstruction by stone with possible pyonephrosis (see here).</text>
</section>
    
```

Illustration of text section template with codes.

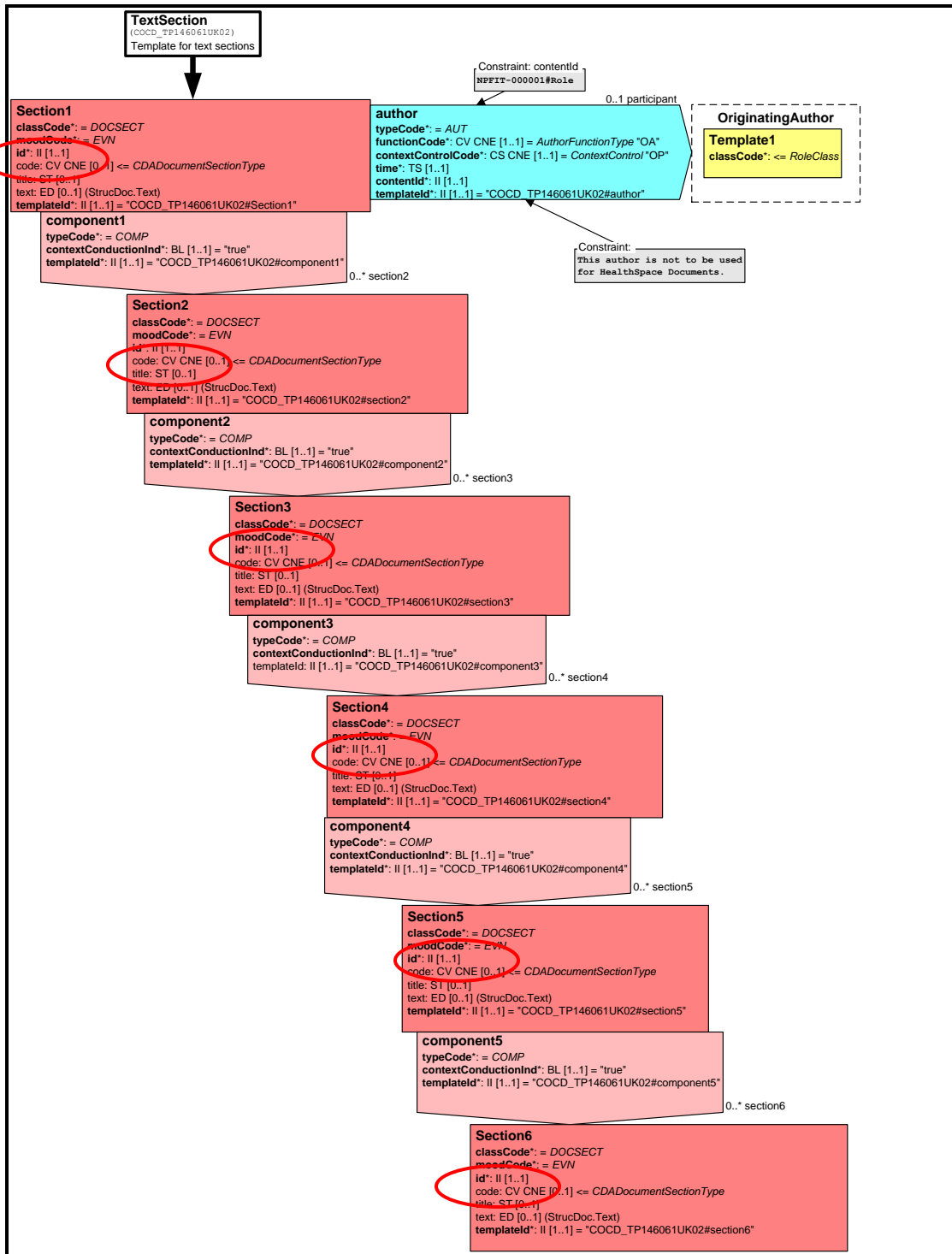

20.9 The Use of html ID in text sections

The Health and Social Care Integration domain allows the use of the html ID attribute to identify / classify certain pieces of text within a text section. The format of the ID is based on the codes contained in the CAInformationSet, TextHeadingType and ComponentHeadingType vocabularies.

The format is code_n where code is a valid code from the aforementioned vocabularies and n is a number from 1 to infinity. (For practical terms infinity should be interpreted as 9999 as it is unlikely in reality that any document will contain more than 9999 IDs). These IDs in line with W3C rules MUST be unique within a document and this is schema enforced.

This allows identification of certain pieces of text in a similar fashion to the use of coded text sections but at a more granular level.

Why use ID ?

When the data is represented in a table format there are the following limitations on text sections and the use of contentID and section code in text sections

1. Tables cannot span text sections
2. contentID referencing cannot span text sections
3. Use of text section code to identify text limited to section level

The use of ID allows the above limitations to be addressed.

The use ID also allows each cell within a table to be uniquely identified.

XML Example of use of ID where the table headings in a Careplan are identified using values from the ComponentTextheadingType vocabulary.

This allows for example a "What will be done" column ID="A" to be identified as Actions / Interventions.

```

<text>
  <table width="100%">
    <thead>
      <tr valign="top" align="left">
        <th ID="I">Identified Needs from the Assessment</th>
        <th ID="G">What are we trying to achieve?</th>
        <th ID="A">What will be done?</th>
        <th ID="R">Who is responsible?</th>
        <th ID="P">Who will do it?</th>
        <th ID="S">When will it be done?</th>
        <th ID="STD">Start Date</th>
        <th ID="ED">End Date</th>
        <th ID="IS">Information Support given</th>
      </tr>
    </thead>
    .....
  </table>

```

Each cell within a column can be further identified using the class with a code of “Component Text Heading Type” and code carried in the value attribute within the coded entry CarePlan component template and the standard CDA referencing mechanism using content ID.

Example of template RMIM

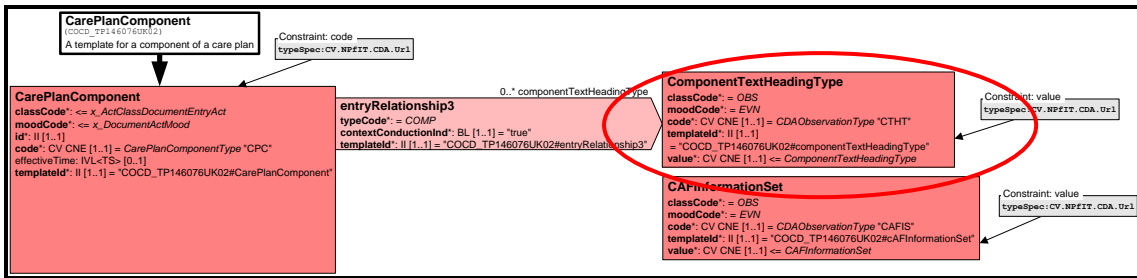

The following 2 example fragments indicating the patient having trouble dressing etc is an “Individual issue”

```

<entryRelationship typeCode="COMP" contextConductionInd="true">
  <templateId root="2.16.840.1.113883.2.1.3.2.4.18.2" extension="COCD_TP146076UK02#entryRelationship3"/>
  <observation moodCode="EVN" classCode="OBS">
    <templateId root="2.16.840.1.113883.2.1.3.2.4.18.2" extension="COCD_TP146076UK02#componentTextHeadingType"/>
    <code codeSystem="2.16.840.1.113883.2.1.3.2.4.17.220" code="CTHT" displayName="Component Text Heading Type"/>
    <value xsi:type="CV.NP&IT.CDA.Uri" code="I" codeSystem="2.16.840.1.113883.2.1.3.2.4.17.224" displayName="Individual Issue (Description of Issue for Individual)">
      <originalText>
        <reference value="#a3"/>
      </originalText>
    </value>
  </observation>
</entryRelationship>
    
```

```

<tbody>
  <tr align="left" valign="top">
    <td>
      <content ID="a3">Is having difficulties with carrying out personal care and dressing tasks</content>
    </td>
    <td>.....</td>
  </tr>
</tbody>
    
```

Note :- The example POCD_EX010004UK01_01.xml in MIM 7.2.00 makes full use of this mechanism

How do systems use IDs in a text section?

- The ID attribute is used by HSCI conformant systems when constructing the HSCIC CDA documents
- HSCI conformant systems may make use of the ID attribute on receipt of a HSCI HSCIC CDA document from another system if so desired.
- All other non HSCI conformant systems when viewing documents should just render the documents using standard rendering rules.

20.10 Illustration ID Usage and TextHeadingType referencing in HSCI

The following illustration shows the use of ID to identify each table column. Also shown are the contentIDs which are used to link each cell to the associated CarePlan Component TextHeadingType.

Plan of Care							
Identified Needs from the Assessment ID="I"	What are we trying to achieve? ID="G"	What will be done? ID="A"	Who is responsible? ID="R"	Who will do it? ID="P"	When will it be done? ID="S"	Start Date ID="SD"	E
ContentID="a3" Is having difficulties with carrying out personal care and dressing tasks	ContentID="a4" Independence with personal care activities	ContentID="a5" Domiciliary support for personal care and dressing tasks for 8 weeks	ContentID="a6" Leigh Timpson, Social Worker, Hebburn Social Services	ContentID="a7" Helping Hands Domiciliary care agency	ContentID="a8" Daily morning call - carer to call for half an hour at 8.30am to assist with washing and dressing. Daily evening call - carer to call for	ContentID="a9" 15-Aug-2007	

```

<entryRelationship typeCode="COMP" contextConductionInd="true">
  <templated root="2.16.840.1.113883.2.1.3.2.4.18.2" extension="COCD_TP146076UK02#entryRelationship3"/>
  <observation moodCode="EVN" classCode="OBS">
    <templated root="2.16.840.1.113883.2.1.3.2.4.18.2" extension="COCD_TP146076UK02#componentTextHeadingType"/>
    <code codeSystem="2.16.840.1.113883.2.1.3.2.4.17.220" code="CTHT" displayName="Component Text Heading Type"/>
    <value xsi:type="CV NPFIT-CDA.U01" code="I" codeSystem="2.16.840.1.113883.2.1.3.2.4.17.224" displayName="Individual Issue (Description of Issue for Individual)">
      <originalText>
        <reference value="#a3"/>
      </originalText>
    </value>
  </observation>
</entryRelationship>
    
```

21 Use of CRE types

The use of CRE types has been revised following restructuring of the HSCIC CDA as per "CCN404. All domains models have the ability to classify clinical statements by CRE type but some domains may not use CRE types when first implemented. The current guidance from HSCIC on CRE types is that CRE type will ONLY be used with mandated coded entries and the only coded entries mandated are Medication and Allergies and Adverse Reactions. Other items can be coded but would NOT be classified by CRE type.

21.1 How CRE type classification is implemented

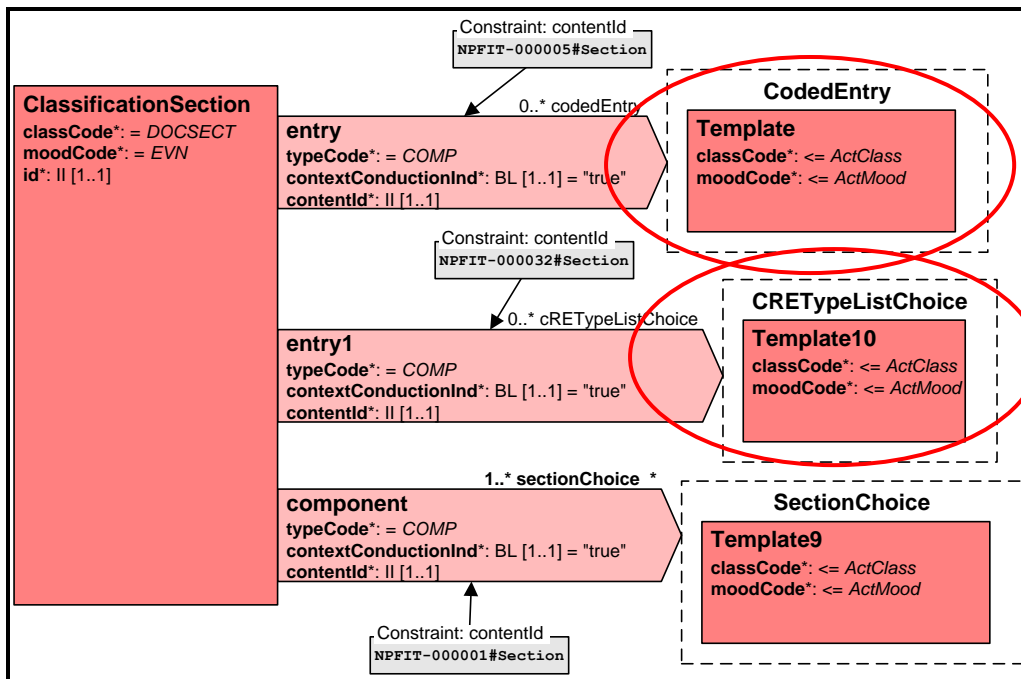

In the illustration above all of the coded entries that are categorised by CRE types will be indexed using 1 occurrence of CRETypeList per CRE type used.

CRE types are implemented using a list of UUIDs carried in CRETypeList.value attribute for the given CRE type carried in the CRETypeList.code attribute. Each UUID must match the UUID carried in the id attribute of the coded entry being categorised. Only 1 instance of the CRETypeList class must be present per CRE type.

21.2 Illustration of CRE type indexing

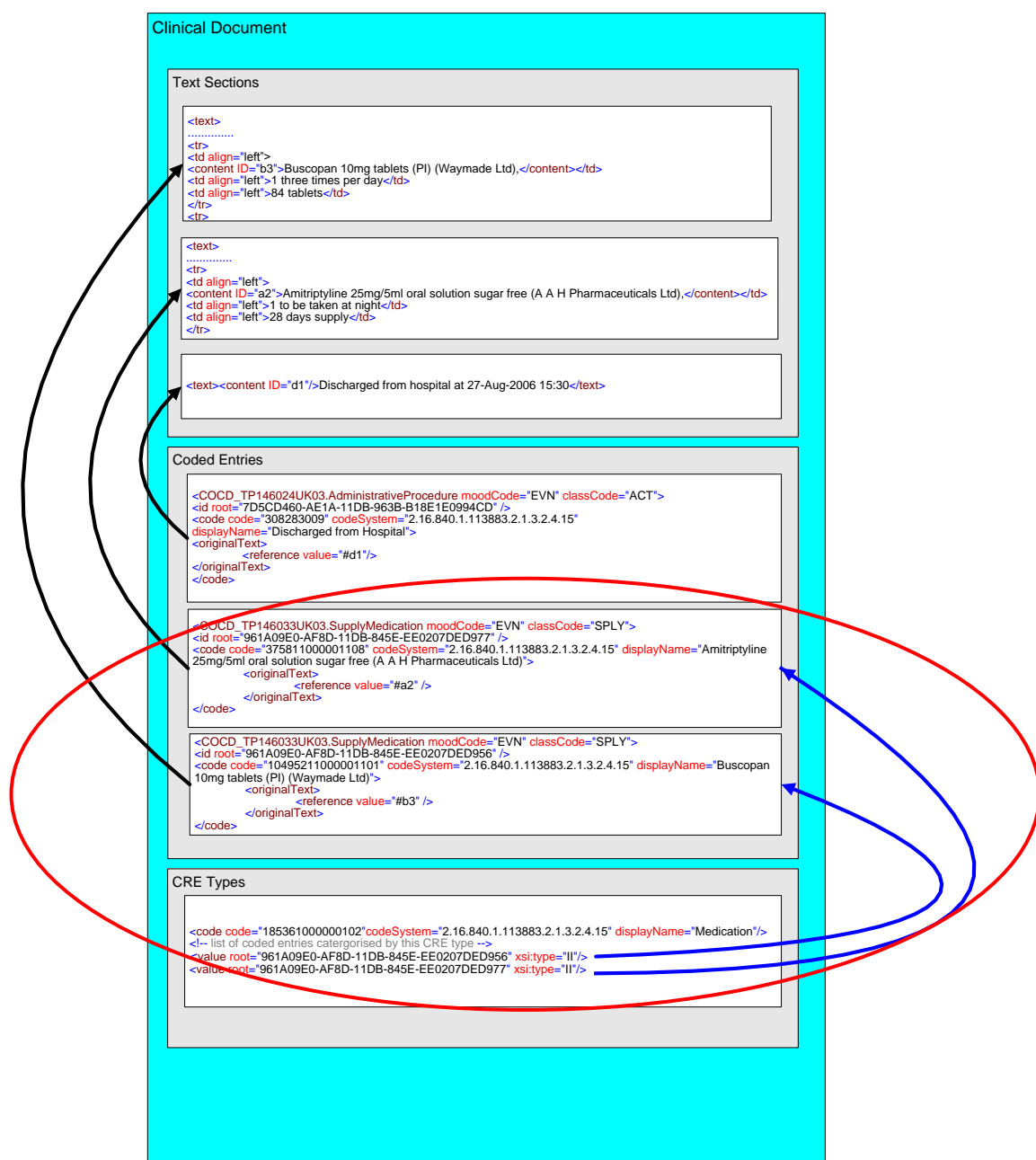

21.3 “On the wire” XML example of CREType categorisation

“On the wire” XML example of CREType list of ids carried in value attribute

```
<entry typeCode="COMP" contextConductionInd="true">
  <npfitct:contentId root="2.16.840.1.113883.2.1.3.2.4.18.16" extension="COCD_TP146062UK01#CRETypeList"/>
  <observation moodCode="EVN" classCode="OBS">
    <templateId root="2.16.840.1.113883.2.1.3.2.4.18.2" extension="COCD_TP146062UK01#CRETypeList"/>
    <code code="185361000000102" codeSystem="2.16.840.1.113883.2.1.3.2.4.15" displayName="Medication"/>
    <value xsi:type="II" root="7D5CD460-AE1A-11DB-962A-B18E1E0994CD"/>
    <value xsi:type="II" root="7D5CD460-AE1A-11DB-962C-B18E1E0994CD"/>
    <value xsi:type="II" root="7D5CD460-AE1A-11DB-962D-B18E1E0994CD"/>
    <value xsi:type="II" root="7D5CD460-AE1A-11DB-963A-B18E1E0994CD"/>
    <value xsi:type="II" root="7D5CD460-AE1A-11DB-963E-B18E1E0994CD"/>
    <value xsi:type="II" root="7D5CD460-AE1A-11DB-9644-B18E1E0994CD"/>
    <value xsi:type="II" root="7D5CD460-AE1A-11DB-964A-B18E1E0994CD"/>
    <value xsi:type="II" root="7D5CD460-AE1A-11DB-9650-B18E1E0994CD"/>
  </observation>
</entry>
```

22 Representing Information Using Templates

The following sections go into detail of how each template is used. Not all templates are detailed here only the templates which are deemed to need further explanation above what is provided in the MIM.

22.1 Representing Vaccinations and Immunisations Using the Treatment Template

This section only applies to the template, which uses SNOMED CT concepts; there is currently no guidance for the equivalent alternative coding template version.

Definitions

Vaccinations – Inoculation with a vaccine in order to protect against a particular disease

Immunisation – the act of making immune (especially by inoculation)

Examples include

- Childhood routine immunizations
- Travel specific vaccinations
- Adult vaccinations Pneumococcal vaccination, 'flu vaccination etc.

The HSCIC template implementation represents vaccinations and Immunisations as procedures using the treatment template and the medication administration templates.

There are two types of representation

1. Simple: - Uses a SNOMED CT procedure concept in Treatment.code of the Treatment template and provides a statement that the vaccination has been given.
 - Indicates which vaccination was performed
 - Indicates when the vaccination was performed
 - Who performed the vaccination
 - The organisation of the person giving treatment
2. Complex: - Uses a SNOMED CT procedure concept in Treatment.code of the Treatment template but additionally provides full details of the medication using the Medication Administration templates.
 1. Indicates which vaccination was performed
 2. Indicates when the vaccination was performed
 3. Who performed the vaccination
 - The organisation scoping the role of the person giving treatment
 - Dosage of the vaccine given
 - Brand name of vaccine given
 - Type of administration
 - Route of administration
 - Batch number
 - Location where administered
 - Reason why administered
 - Link to request or plan to administer the vaccine

Known issues

Reason for medication in the medication template when used with vaccines is always the treatment; however, the medication templates allow a wide range of reasons. The Treatment template with its optional reference to the medication administration also allows medications other than the required administration ones.

Therefore, a separate template would be a better way forward in the future.

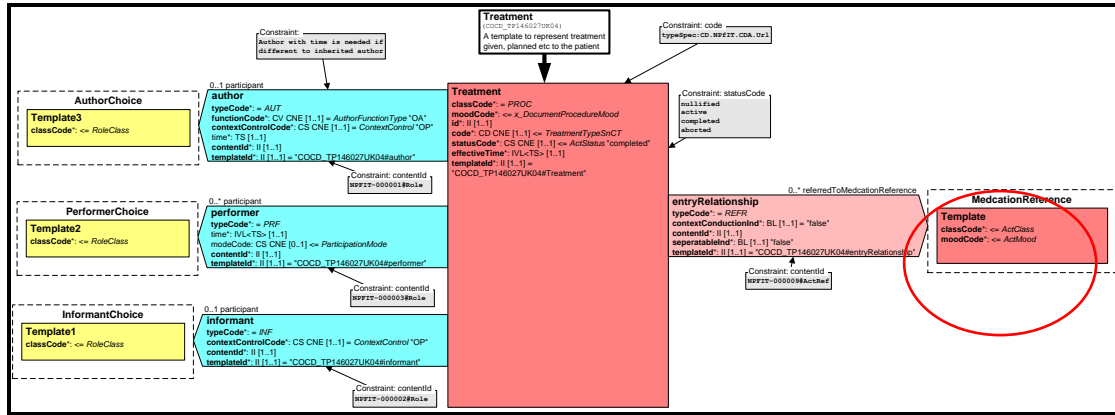

“on the wire” example instance of “simple” representation using just treatment template

Treatment instance example

```

<entry typeCode="COMP" contextConductionInd="true">
  <npfitt:contentId root="2.16.840.1.113883.2.1.3.2.4.18.16" extension="COCD_TP146027UK03#Treatment"/>
  <procedure classCode="PROC" moodCode="EVN">
    <templateId root="2.16.840.1.113883.2.1.3.2.4.18.2" extension="COCD_TP146027UK04#Treatment"/>
    <id root="3E25ACE2-23F8-4A37-B446-6A37F31BF77B"/>
    <code code="170415002" codeSystem="2.16.840.1.113883.2.1.3.2.4.15" displayName="Booster diphtheria and tetanus double and polio vaccination"/>
    <statusCode code="completed"/>
    <effectiveTime>
      <center value="200609221400"/>
    </effectiveTime>
    <performer typeCode="PRF">
      <templateId root="2.16.840.1.113883.2.1.3.2.4.18.2" extension="COCD_TP146027UK04#performer"/>
      <npfitt:contentId root="2.16.840.1.113883.2.1.3.2.4.18.16" extension="COCD_TP145022UK01#AssignedEntitySDS"/>
      <time value="200601280915"/>
      <assignedEntity classCode="ASSIGNED">
        <templateId root="2.16.840.1.113883.2.1.3.2.4.18.2" extension="COCD_TP145022UK01#AssignedEntitySDS"/>
        <id root="1.2.826.0.1285.0.2.0.67" extension="100096655241"/>
        <id root="1.2.826.0.1285.0.2.0.65" extension="200044213298"/>
        <code code="R1293" displayName="Nurse" codeSystem="2.16.840.1.113883.2.1.3.2.4.17.196"/>
        <assignedPerson classCode="PSN" determinerCode="INSTANCE">
          <templateId root="2.16.840.1.113883.2.1.3.2.4.18.2" extension="COCD_TP145022UK01#assignedPerson"/>
          <name>Ms. Jenny Alberta</name>
        </assignedPerson>
      </assignedEntity>
    </performer>
  </procedure>
</entry>

```

“on the wire” example instance of “complex” representation using treatment template and administer medication dose linked by reference (ActRef).

Treatment extract from instance

```
<entry typeCode="COMP" contextConductionInd="true">
  <npfIct:contentId root="2.16.840.1.113883.2.1.3.2.4.18.16" extension="COCD_TP146027UK03#Treatment"/>
  <procedure classCode="PROC" moodCode="EVN">
    <templateId root="2.16.840.1.113883.2.1.3.2.4.18.2" extension="COCD_TP146027UK04#Treatment"/>
    <id root="3E25ACE2-23F8-4A37-B446-6A37F31BF77B"/>
    <code code="170333009" codeSystem="2.16.840.1.113883.2.1.3.2.4.15" displayName="Booster tetanus vaccination"/>
    <statusCode code="completed"/>
    <effectiveTime>
      <center value="200609221400"/>
    </effectiveTime>
    <performer typeCode="PRF">
      <templateId root="2.16.840.1.113883.2.1.3.2.4.18.2" extension="COCD_TP146027UK04#performer"/>
      <npfIct:contentId root="2.16.840.1.113883.2.1.3.2.4.18.16" extension="COCD_TP145022UK01#AssignedEntitySDS"/>
      <time value="200601280915"/>
      <assignedEntity classCode="ASSIGNED">
        <templateId root="2.16.840.1.113883.2.1.3.2.4.18.2" extension="COCD_TP145022UK01#AssignedEntitySDS"/>
        <id root="1.2.826.0.1285.0.2.0.67" extension="100096655241"/>
        <id root="1.2.826.0.1285.0.2.0.65" extension="200044213298"/>
        <code code="R1293" displayName="Nurse" codeSystem="2.16.840.1.113883.2.1.3.2.4.17.196"/>
        <assignedPerson classCode="PSN" determinerCode="INSTANCE">
          <templateId root="2.16.840.1.113883.2.1.3.2.4.18.2" extension="COCD_TP145022UK01#assignedPerson"/>
          <name>Ms. Jenny Alberta</name>
        </assignedPerson>
      </assignedEntity>
    </performer>
    <entryRelationship typeCode="REFR" contextConductionInd="false">
      <templateId root="2.16.840.1.113883.2.1.3.2.4.18.2" extension="COCD_TP146027UK04#entryRelationship"/>
      <npfIct:contentId root="2.16.840.1.113883.2.1.3.2.4.18.16" extension="COCD_TP147029UK04#MedicationAdministrationDoseRef"/>
      <seperatableInd value="false"/>
      <substanceAdministration moodCode="EVN" classCode="SBADM">
        <templateId root="2.16.840.1.113883.2.1.3.2.4.18.2" extension="COCD_TP147029UK04#MedicationAdministrationDoseRef"/>
        <id root="4E25ACE2-24F8-4A47-B446-6A47F41BF77B"/>
        <code nullFlavor="NA"/>
        <consumable typeCode="CSM">
          <manufacturedProduct classCode="MANU">
            <manufacturedMaterial determinerCode="KIND" classCode="MMAT"/>
          </manufacturedProduct>
        </consumable>
      </substanceAdministration>
    </entryRelationship>
  </procedure>
</entry>
```

Reference to the medication within

Medication extract from instance

```
<entry typeCode="COMP" contextConductionInd="true">
  <npfIct:contentId root="2.16.840.1.113883.2.1.3.2.4.18.16" extension="COCD_TP146029UK04#MedicationAdministrationDose"/>
  <substanceAdministration moodCode="EVN" classCode="SBADM">
    <templateId root="2.16.840.1.113883.2.1.3.2.4.18.2" extension="COCD_TP146029UK04#MedicationAdministrationDose"/>
    <id root="4E25ACE2-24F8-4A47-B446-6A47F41BF77B"/>
    <code code="386356001" codeSystem="2.16.840.1.113883.2.1.3.2.4.15" displayName="Medication administration: intramuscular"/>
    <statusCode code="completed"/>
    <effectiveTime>
      <center value="200609221400"/>
    </effectiveTime>
    <consumable typeCode="CSM">
      <templateId root="2.16.840.1.113883.2.1.3.2.4.18.2" extension="COCD_TP146029UK04#consumable"/>
      <manufacturedProduct classCode="MANU">
        <templateId root="2.16.840.1.113883.2.1.3.2.4.18.2" extension="COCD_TP146029UK04#manufacturedProduct"/>
        <manufacturedMaterial determinerCode="KIND" classCode="MMAT">
          <templateId root="2.16.840.1.113883.2.1.3.2.4.18.2" extension="COCD_TP146029UK04#manufacturedMaterial"/>
          <code code="3002411000001104" codeSystem="2.16.840.1.113883.2.1.3.2.4.15" displayName="Clostet vaccine suspension for injection 0.5ml pre-filled syringes (Novartis Vaccines and Diagnostics Ltd)"/>
          <lotNumberText>1234567YU</lotNumberText>
        </manufacturedMaterial>
      </manufacturedProduct>
    </consumable>
    <entryRelationship typeCode="COMP" contextConductionInd="true">
      <templateId root="2.16.840.1.113883.2.1.3.2.4.18.2" extension="COCD_TP146029UK04#entryRelationship1"/>
      <seperatableInd value="false"/>
      <observation moodCode="EVN" classCode="OBS">
        <templateId root="2.16.840.1.113883.2.1.3.2.4.18.2" extension="COCD_TP146029UK04#administrationDetails"/>
        <code codeSystem="2.16.840.1.113883.2.1.3.2.4.17.192" code="AD" displayName="Medication administration Instructions"/>
        <value xsi:type="ST">0.5ml injected, intramuscular - left upper arm</value>
      </observation>
    </entryRelationship>
    <entryRelationship typeCode="COMP" contextConductionInd="true">
      <templateId root="2.16.840.1.113883.2.1.3.2.4.18.2" extension="COCD_TP146029UK04#entryRelationship3"/>
      <observation moodCode="EVN" classCode="OBS">
        <templateId root="2.16.840.1.113883.2.1.3.2.4.18.2" extension="COCD_TP146029UK04#administrationType"/>
        <code codeSystem="2.16.840.1.113883.2.1.3.2.4.17.192" code="AT" displayName="Medication administration type"/>
        <value xsi:type="CV" codeSystem="2.16.840.1.113883.2.1.3.2.4.17.185" code="DO" displayName="administration of a dose"/>
      </observation>
    </entryRelationship>
  </substanceAdministration>
</entry>
```

22.2 CarePlan and CarePlan Component Templates

The CarePlan templates allow recording of CarePlan information and also if required individual components of the CarePlan . Both the care plan and its components can be categorized using the text heading type code list. The component can be additionally categorized using the CAF Information set code list. Details of the categorization mechanisms are detailed in section 20 of this document. The component template is only used with the CarePlan template.

The templates allow the recording of information such as

- The type of CarePlan
- Author of Care Plan

- Author of an individual Component
- Person or organisation responsible for Care Plan
- Person or organisation responsible for Care Plan individual component
- Performer of Care Plan
- Performer of an individual component
- Other people present when Care Plan was made (Witness)
- Details of people who received copy of the CarePlan in another format i.e paper , email etc
- Whether the patient was given a copy of the CarePlan
- Whether the patient agrees with the CarePlan
- Review Dates associated with the CarePlan
- Review Dates associated with the individual component
- Start and end dates of the CarePlan
- Start and end dates of the individual component
- Issues relating to / associated with a component
- Information supporting a component
- Actions associated with a component

22.3 Abstract Illustration of CarePlan and CarePlan Component

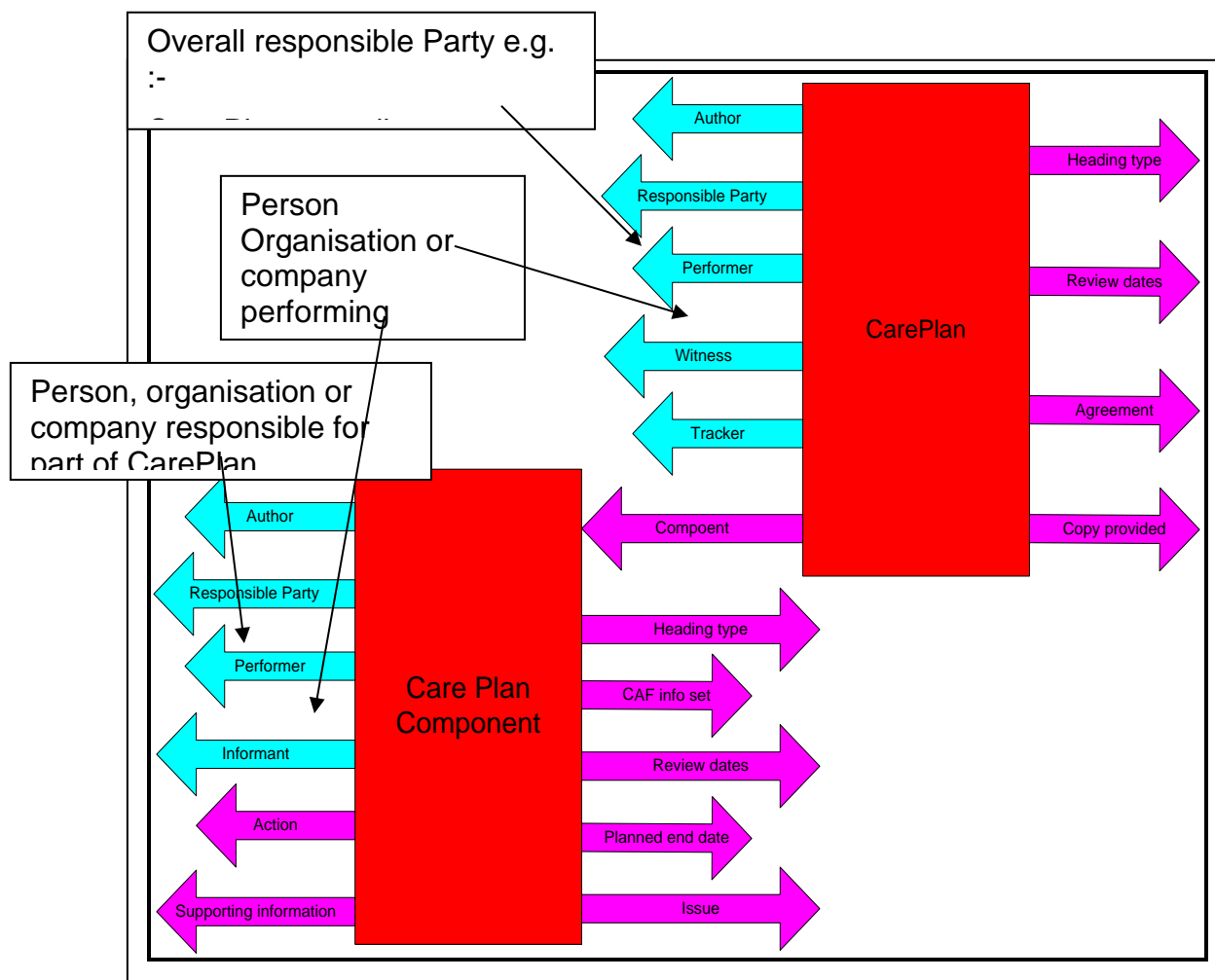

22.4 Assessment and Assessment Event Templates

These templates allow recording of assessment and details of the care event during which the assessment took place. Both the templates can be used standalone or combined.

The Assessment Event template allows recording of information such as

- Where the Assessment took place
- Type of care setting where the Assessment was made
- Author of the Assessment Event
- Performers involved in the Assessment
- People informing at the Assessment Event
- Other people present during the Assessment such as a carer or family member
- Type of encounter during which the Assessment took place

The Assessment template allows recording of information such as

- Author of the Assessment
- Performers involved in the Assessment
- People informing at the Assessment
- Other people present during the Assessment such as a carer or family member
- Tools used during Assessments such as Computer systems ,Software and applications
- Scales used during the Assessment
- Factors to be considered / relevant to the Assessment
- Review dates
- Start and end dates
- Type of Assessment

22.5 Representing Assessments With or Without Scales

Assessments come in many forms therefore the Assessment template supports multiple ways to represent Assessments, including :-

- An Assessment with Single or Multiple Component Assessments with nested component Assessments using a single scale , multiple scales or no scale(1)
- An Assessment with Multiple Component Assessments with each using a separate scale(2)
- An Assessment with a single scale (3)
- A simple Assessment representation with no scale (4)

Note the illustrations below are not the complete Assessment template model.

An Assessment with Single or Multiple Component Assessments with nested component Assessments using a single scale , multiple scales or no scale (1)

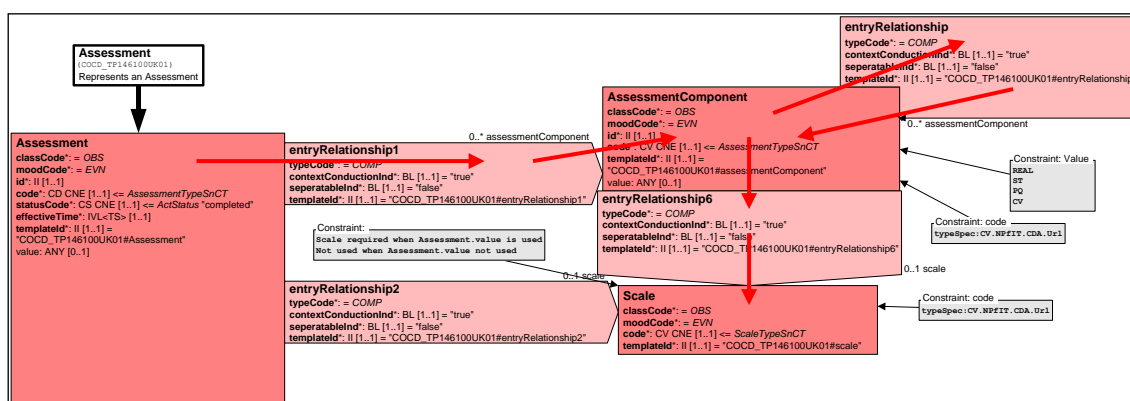

An Assessment with Multiple Component Assessments with each a separate scale (2)

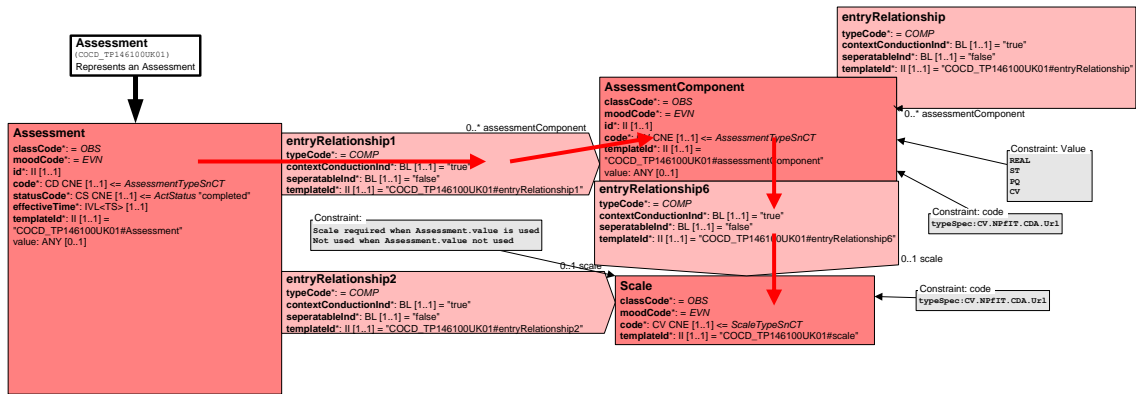

An Assessment with a single scale (3)

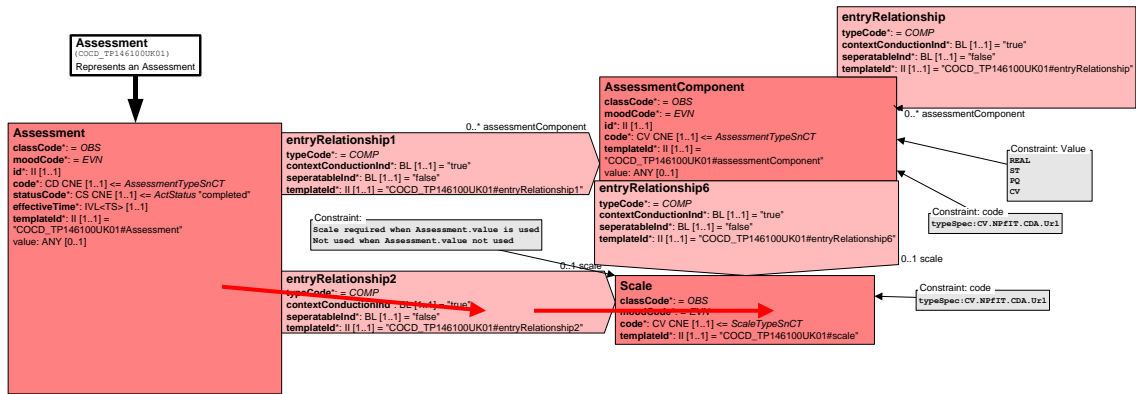

A simple Assessment representation with no scale (4)

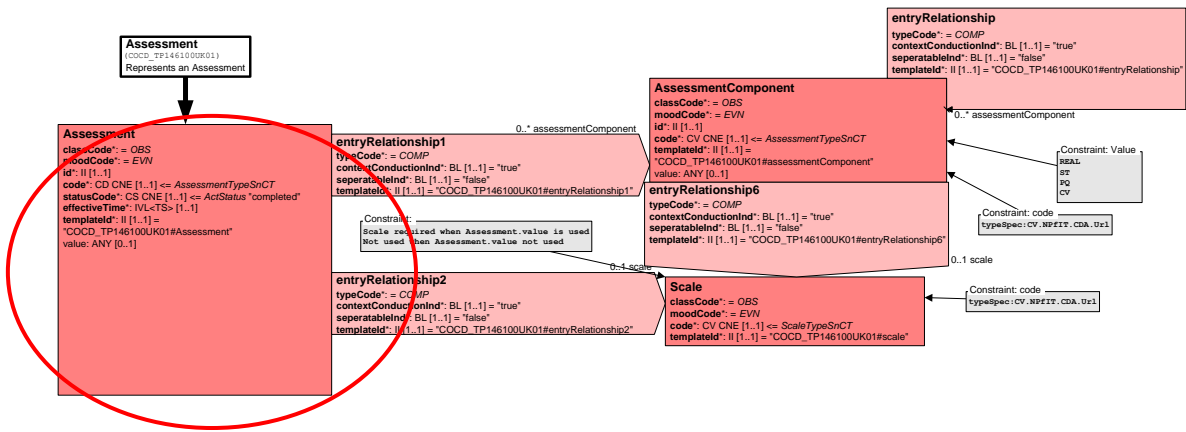

22.6 Examples of Representing Assessments

*** Important Note *** Some of the SNOMED CT codes used in these example were not available from TRUD at the time of publication of this document. These codes are currently being authored for the next release.

Example of an Assessment with a single Component Assessment with no scale (1)

```

<observation classCode="OBS" moodCode="EVN">
  <templateId extension="COCD_TP146100UK01#Assessment" root="2.16.840.1.113883.2.1.3.2.4.18.2"/>
  <id root="2DAC4438-B46F-4A90-BB2A-5790E311EFD1"/>
  <code code="225338004" codeSystem="2.16.840.1.113883.2.1.3.2.4.15" displayName="Risk assessment"/>
  <statusCode code="completed"/>
  <effectiveTime>
    <center value="20060910"/>
  </effectiveTime>
  <entryRelationship contextConductionInd="true" typeCode="COMP">
    <templateId extension="COCD_TP146100UK01#entryRelationship1" root="2.16.840.1.113883.2.1.3.2.4.18.2"/>
    <seperatableInd value="false"/>
    <observation classCode="OBS" moodCode="EVN">
      <templateId extension="COCD_TP146100UK01#assessmentComponent" root="2.16.840.1.113883.2.1.3.2.4.18.2"/>
      <id root="DAF153D6-C962-4889-B413-D335366F9462"/>
      <code code="TBA" codeSystem="2.16.840.1.113883.2.1.3.2.4.15" displayName="Violence to adults">
        </code>
      <value xsi:type="ST">Medium</value>
    </observation>
  </entryRelationship>
</observation>

```

Example of an Assessment with multiple Component Assessments with no scale (1)

```

<?xml version="1.0" encoding="UTF-8"?>
<observation classCode="OBS" moodCode="EVN">
  <templateId extension="COCD_TP146100UK01#Assessment" root="2.16.840.1.113883.2.1.3.2.4.18.2"/>
  <id root="2DAC4438-B46F-4A90-BB2A-5790E311EFD1"/>
  <code code="225338004" codeSystem="2.16.840.1.113883.2.1.3.2.4.15" displayName="Risk assessment"/>
  <status code="completed"/>
  <effectiveTime>
    <center value="20060910"/>
  </effectiveTime>
  <entryRelationship contextConductionInd="true" typeCode="COMP">
    <templateId extension="COCD_TP146100UK01#entryRelationship1" root="2.16.840.1.113883.2.1.3.2.4.18.2"/>
    <seperatableInd value="false"/>
    <observation classCode="OBS" moodCode="EVN">
      <templateId extension="COCD_TP146100UK01#assessmentComponent" root="2.16.840.1.113883.2.1.3.2.4.18.2"/>
      <id root="DAF153D6-C962-4889-B413-D335366F9462"/>
      <code code="TBA" codeSystem="2.16.840.1.113883.2.1.3.2.4.15" displayName="Suicide"/>
      <value xsi:type="ST">Low</value>
    </observation>
  </entryRelationship>
  <entryRelationship contextConductionInd="true" typeCode="COMP">
    <templateId extension="COCD_TP146100UK01#entryRelationship1" root="2.16.840.1.113883.2.1.3.2.4.18.2"/>
    <seperatableInd value="false"/>
    <observation classCode="OBS" moodCode="EVN">
      <templateId extension="COCD_TP146100UK01#assessmentComponent" root="2.16.840.1.113883.2.1.3.2.4.18.2"/>
      <id root="DAF153D6-C962-4889-B413-D335366F9462"/>
      <code code="TBA" codeSystem="2.16.840.1.113883.2.1.3.2.4.15" displayName="Self harm"/>
      <value xsi:type="ST">Low</value>
    </observation>
  </entryRelationship>
  <entryRelationship contextConductionInd="true" typeCode="COMP">
    <templateId extension="COCD_TP146100UK01#entryRelationship1" root="2.16.840.1.113883.2.1.3.2.4.18.2"/>
    <seperatableInd value="false"/>
    <observation classCode="OBS" moodCode="EVN">
      <templateId extension="COCD_TP146100UK01#assessmentComponent" root="2.16.840.1.113883.2.1.3.2.4.18.2"/>
      <id root="DAF153D6-C962-4889-B413-D335366F9462"/>
      <code code="TBA" codeSystem="2.16.840.1.113883.2.1.3.2.4.15" displayName="Accident"/>
      <value xsi:type="ST">Medium</value>
    </observation>
  </entryRelationship>
  <entryRelationship contextConductionInd="true" typeCode="COMP">
    <templateId extension="COCD_TP146100UK01#entryRelationship1" root="2.16.840.1.113883.2.1.3.2.4.18.2"/>
    <seperatableInd value="false"/>
    <observation classCode="OBS" moodCode="EVN">
      <templateId extension="COCD_TP146100UK01#assessmentComponent" root="2.16.840.1.113883.2.1.3.2.4.18.2"/>
      <id root="DAF153D6-C962-4889-B413-D335366F9462"/>
      <code code="TBA" codeSystem="2.16.840.1.113883.2.1.3.2.4.15" displayName="Self neglect"/>
      <value xsi:type="ST">High</value>
    </observation>
  </entryRelationship>
  <entryRelationship contextConductionInd="true" typeCode="COMP">
    <templateId extension="COCD_TP146100UK01#entryRelationship1" root="2.16.840.1.113883.2.1.3.2.4.18.2"/>
    <seperatableInd value="false"/>
    <observation classCode="OBS" moodCode="EVN">
      <templateId extension="COCD_TP146100UK01#assessmentComponent" root="2.16.840.1.113883.2.1.3.2.4.18.2"/>
      <id root="DAF153D6-C962-4889-B413-D335366F9462"/>
      <code code="TBA" codeSystem="2.16.840.1.113883.2.1.3.2.4.15" displayName="Vulnerability"/>
      <value xsi:type="ST">Medium</value>
    </observation>
  </entryRelationship>
  <entryRelationship contextConductionInd="true" typeCode="COMP">
    <templateId extension="COCD_TP146100UK01#entryRelationship1" root="2.16.840.1.113883.2.1.3.2.4.18.2"/>
    <seperatableInd value="false"/>
    <observation classCode="OBS" moodCode="EVN">
      <templateId extension="COCD_TP146100UK01#assessmentComponent" root="2.16.840.1.113883.2.1.3.2.4.18.2"/>
      <id root="DAF153D6-C962-4889-B413-D335366F9462"/>
      <code code="TBA" codeSystem="2.16.840.1.113883.2.1.3.2.4.15" displayName="Violence to adults"/>
      <value xsi:type="ST">Medium</value>
    </observation>
  </entryRelationship>
  <entryRelationship contextConductionInd="true" typeCode="COMP">
    <templateId extension="COCD_TP146100UK01#entryRelationship1" root="2.16.840.1.113883.2.1.3.2.4.18.2"/>
    <seperatableInd value="false"/>
    <observation classCode="OBS" moodCode="EVN">
      <templateId extension="COCD_TP146100UK01#assessmentComponent" root="2.16.840.1.113883.2.1.3.2.4.18.2"/>
      <id root="DAF153D6-C962-4889-B413-D335366F9462"/>
      <code code="TBA" codeSystem="2.16.840.1.113883.2.1.3.2.4.15" displayName="Aggression to adults"/>
      <value xsi:type="ST">High</value>
    </observation>
  </entryRelationship>
  <entryRelationship contextConductionInd="true" typeCode="COMP">
    <templateId extension="COCD_TP146100UK01#entryRelationship1" root="2.16.840.1.113883.2.1.3.2.4.18.2"/>
    <seperatableInd value="false"/>
    <observation classCode="OBS" moodCode="EVN">
      <templateId extension="COCD_TP146100UK01#assessmentComponent" root="2.16.840.1.113883.2.1.3.2.4.18.2"/>
      <id root="DAF153D6-C962-4889-B413-D335366F9462"/>
      <code code="TBA" codeSystem="2.16.840.1.113883.2.1.3.2.4.15" displayName="Abuse of adults"/>
      <value xsi:type="ST">Medium</value>
    </observation>
  </entryRelationship>
  <entryRelationship contextConductionInd="true" typeCode="COMP">
    <templateId extension="COCD_TP146100UK01#entryRelationship1" root="2.16.840.1.113883.2.1.3.2.4.18.2"/>
    <seperatableInd value="false"/>
    <observation classCode="OBS" moodCode="EVN">
      <templateId extension="COCD_TP146100UK01#assessmentComponent" root="2.16.840.1.113883.2.1.3.2.4.18.2"/>
      <id root="DAF153D6-C962-4889-B413-D335366F9462"/>
      <code code="TBA" codeSystem="2.16.840.1.113883.2.1.3.2.4.15" displayName="Neglect of adults"/>
      <value xsi:type="ST">Medium</value>
    </observation>
  </entryRelationship>
</observation>

```

Example of an Assessment with a Component Assessment with a single scale (1)

```

<observation classCode="OBS" moodCode="EVN">
  <templateId extension="COCD_TP146100UK01#Assessment" root="2.16.840.1.113883.2.1.3.2.4.18.2"/>
  <id root="2DAC4438-C46F-4A90-BB2A-5790E311EFD1"/>
  <code code="TBA" codeSystem="2.16.840.1.113883.2.1.3.2.4.15" displayName="HCR-20 Assessment"/>
  <statusCode code="completed"/>
  <effectiveTime>
    <center value="20060910"/>
  </effectiveTime>
  <entryRelationship contextConductionInd="true" typeCode="COMP">
    <templateId extension="COCD_TP146100UK01#entryRelationship1" root="2.16.840.1.113883.2.1.3.2.4.18.2"/>
    <seperatableInd value="false"/>
    <observation classCode="OBS" moodCode="EVN">
      <templateId extension="COCD_TP146100UK01#assessmentComponent" root="2.16.840.1.113883.2.1.3.2.4.18.2"/>
      <id root="DAF153D6-C962-4889-B413-D335366F9462"/>
      <code code="TBA" codeSystem="2.16.840.1.113883.2.1.3.2.4.15" displayName="H1 - Previous Violence"/>
      <value xsi:type="CV" code="TBA" codeSystem="2.16.840.1.113883.2.1.3.2.4.15" displayName="1"/>
      <entryRelationship contextConductionInd="true" typeCode="COMP">
        <templateId extension="COCD_TP146100UK01#entryRelationship6" root="2.16.840.1.113883.2.1.3.2.4.18.2"/>
        <seperatableInd value="false"/>
        <observation classCode="OBS" moodCode="EVN">
          <templateId extension="COCD_TP146100UK01#scale" root="2.16.840.1.113883.2.1.3.2.4.18.2"/>
          <code code="TBA" codeSystem="2.16.840.1.113883.2.1.3.2.4.15" displayName="HCR-20 Scale"/>
        </observation>
      </entryRelationship>
    </observation>
  </entryRelationship>
</observation>

```

Example of an Assessment with multiple nested Component Assessments each with a separate scale (2)

```

<?xml version="1.0" encoding="UTF-8"?>
<entry contextConductionInd="true" typeCode="COMP">
  <npf:tlc:contentId extension="COCD_TP146100UK01#Assessment" root="2.16.840.1.113883.2.1.3.2.4.18.16"/>
  <observation classCode="OBS" moodCode="EVN">
    <templateId extension="COCD_TP146100UK01#Assessment" root="2.16.840.1.113883.2.1.3.2.4.18.2"/>
    <id root="2DAC4438-B46F-4B90-BB2A-5790E331EFD1"/>
    <code code="391281002" codeSystem="2.16.840.1.113883.2.1.3.2.4.15" displayName="mental health assessment"/>
    <status code="completed"/>
    <effectiveTime>
      <center value="20040101"/>
    </effectiveTime>
  </observation>
  <entryRelationship contextConductionInd="true" typeCode="COMP">
    <templateId extension="COCD_TP146100UK01#entryRelationship1" root="2.16.840.1.113883.2.1.3.2.4.18.2"/>
    <seperableInd value="false"/>
    <observation classCode="OBS" moodCode="EVN">
      <templateId extension="COCD_TP146100UK01#assessmentComponent" root="2.16.840.1.113883.2.1.3.2.4.18.2"/>
      <id root="DAF150DE-C962-4889-B413-D335366F9362"/>
      <code code="165320004" codeSystem="2.16.840.1.113883.2.1.3.2.4.15" displayName="dementia test"/>
      <entryRelationship typeCode="COMP" contextConductionInd="true">
        <templateId root="2.16.840.1.113883.2.1.3.2.4.18.2" extension="COCD_TP146100UK01#entryRelationship"/>
        <seperableInd value="false"/>
        <observation moodCode="EVN" classCode="OBS">
          <templateId root="2.16.840.1.113883.2.1.3.2.4.18.2" extension="COCD_TP146100UK01#assessmentComponent"/>
          <id root="2DAC4438-B46F-4B90-BB2A-5790E331EFD3"/>
          <code code="272051008" codeSystem="2.16.840.1.113883.2.1.3.2.4.15" displayName="memory assessment"/>
          <value xsi:type="REAL" value="0.5"/>
          <entryRelationship typeCode="COMP" contextConductionInd="true">
            <templateId root="2.16.840.1.113883.2.1.3.2.4.18.2" extension="COCD_TP146100UK01#entryRelationship6"/>
            <seperableInd value="false"/>
            <observation moodCode="EVN" classCode="OBS">
              <templateId root="2.16.840.1.113883.2.1.3.2.4.18.2" extension="COCD_TP146100UK01#scale"/>
              <code code="273367002" codeSystem="2.16.840.1.113883.2.1.3.2.4.15" displayName="Clinical dementia rating scale"/>
            </observation>
          </entryRelationship>
        </observation>
      </entryRelationship>
    </entryRelationship>
  </entryRelationship>
  <entryRelationship typeCode="COMP" contextConductionInd="true">
    <templateId root="2.16.840.1.113883.2.1.3.2.4.18.2" extension="COCD_TP146100UK01#entryRelationship"/>
    <seperableInd value="false"/>
    <observation moodCode="EVN" classCode="OBS">
      <templateId root="2.16.840.1.113883.2.1.3.2.4.18.2" extension="COCD_TP146100UK01#assessmentComponent"/>
      <id root="2DAC4438-B46F-4B90-BB2A-5790E331EFD3"/>
      <code code="247581008" codeSystem="2.16.840.1.113883.2.1.3.2.4.15" displayName="problem solving"/>
      <value xsi:type="REAL" value="1"/>
      <entryRelationship typeCode="COMP" contextConductionInd="true">
        <templateId root="2.16.840.1.113883.2.1.3.2.4.18.2" extension="COCD_TP146100UK01#entryRelationship6"/>
        <seperableInd value="false"/>
        <observation moodCode="EVN" classCode="OBS">
          <templateId root="2.16.840.1.113883.2.1.3.2.4.18.2" extension="COCD_TP146100UK01#scale"/>
          <code code="273367002" codeSystem="2.16.840.1.113883.2.1.3.2.4.15" displayName="Clinical dementia rating scale"/>
        </observation>
      </entryRelationship>
    </observation>
  </entryRelationship>
  </entryRelationship>
  </entryRelationship>
  <entryRelationship typeCode="COMP" contextConductionInd="true">
    <templateId root="2.16.840.1.113883.2.1.3.2.4.18.2" extension="COCD_TP146100UK01#entryRelationship1"/>
    <seperableInd value="false"/>
    <observation moodCode="EVN" classCode="OBS">
      <templateId root="2.16.840.1.113883.2.1.3.2.4.18.2" extension="COCD_TP146100UK01#assessmentComponent"/>
      <id root="2DAC4438-B46F-4B90-BB2A-5790E371EFD3"/>
      <code code="405051006" codeSystem="2.16.840.1.113883.2.1.3.2.4.15" displayName="anxiety level"/>
      <value xsi:type="REAL" value="7"/>
      <entryRelationship typeCode="COMP" contextConductionInd="true">
        <templateId root="2.16.840.1.113883.2.1.3.2.4.18.2" extension="COCD_TP146100UK01#entryRelationship6"/>
        <seperableInd value="false"/>
        <observation moodCode="EVN" classCode="OBS">
          <templateId root="2.16.840.1.113883.2.1.3.2.4.18.2" extension="COCD_TP146100UK01#scale"/>
          <code code="273524006" codeSystem="2.16.840.1.113883.2.1.3.2.4.15" displayName="HADS - Hospital anxiety and depression scale"/>
        </observation>
      </entryRelationship>
    </observation>
  </entryRelationship>
  </entryRelationship>
  <entryRelationship typeCode="COMP" contextConductionInd="true">
    <templateId root="2.16.840.1.113883.2.1.3.2.4.18.2" extension="COCD_TP146100UK01#entryRelationship1"/>
    <seperableInd value="false"/>
    <observation moodCode="EVN" classCode="OBS">
      <templateId root="2.16.840.1.113883.2.1.3.2.4.18.2" extension="COCD_TP146100UK01#assessmentComponent"/>
      <id root="2DAC4438-B46F-4B90-BB2A-5790E371EFD3"/>
      <code code="405049007" codeSystem="2.16.840.1.113883.2.1.3.2.4.15" displayName="Depression level"/>
      <value xsi:type="REAL" value="6"/>
      <entryRelationship typeCode="COMP" contextConductionInd="true">
        <templateId root="2.16.840.1.113883.2.1.3.2.4.18.2" extension="COCD_TP146100UK01#entryRelationship6"/>
        <seperableInd value="false"/>
        <observation moodCode="EVN" classCode="OBS">
          <templateId root="2.16.840.1.113883.2.1.3.2.4.18.2" extension="COCD_TP146100UK01#scale"/>
          <code code="273524006" codeSystem="2.16.840.1.113883.2.1.3.2.4.15" displayName="HADS - Hospital anxiety and depression scale"/>
        </observation>
      </entryRelationship>
    </observation>
  </entryRelationship>
  </entryRelationship>
  </entryRelationship>
</entry>
  
```

Example of a single Assessment with a single scale (3)

```

<observation moodCode="EVN" classCode="OBS">
  <templateId root="2.16.840.1.113883.2.1.3.2.4.18.2" extension="COCD_TP146100UK01#Assessment"/>
  <id root="7D616840-AE1A-11DB-972C-B18E1E0994CD"/>
  <code code="410155007" codeSystem="2.16.840.1.113883.2.1.3.2.4.15" displayName="occupational therapy assessment"/>
  <statusCode code="completed"/>
  <effectiveTime>
    <low value="200708171030"/>
    <high value="200708171230"/>
  </effectiveTime>
  <value xsi:type="REAL" value="65"/>
  <entryRelationship typeCode="COMP" contextConductionInd="true">
    <templateId root="2.16.840.1.113883.2.1.3.2.4.18.2" extension="COCD_TP146100UK01#entryRelationship2"/>
    <seperatableInd value="false"/>
    <observation moodCode="EVN" classCode="OBS">
      <templateId root="2.16.840.1.113883.2.1.3.2.4.18.2" extension="COCD_TP146100UK01#scale"/>
      <code code="273302005" displayName="Barthel index" codeSystem="2.16.840.1.113883.2.1.3.2.4.15"/>
    </observation>
  </entryRelationship>
</observation>
    
```

Example of a Simple Assessment representation using no scale (4)

```

<observation moodCode="EVN" classCode="OBS">
  <templateId root="2.16.840.1.113883.2.1.3.2.4.18.2" extension="COCD_TP146100UK01#Assessment"/>
  <id root="7D616840-AE1A-11DB-972A-B18E1E0994CD"/>
  <code code="193241000000107" codeSystem="2.16.840.1.113883.2.1.3.2.4.15" displayName="single Assessment Process overview assessment"/>
  <statusCode code="completed"/>
  <effectiveTime>
    <center value="20070814"/>
  </effectiveTime>
</observation>
    
```

23 HSCI099REQ: New Document Recipient

This section details the technical information required by vendors to implement the business requirement HSCI099REQ: New Document Recipient.

This section must be read in conjunction with latest version of the HSCI business requirements catalogue.

The requirement is to allow a HSCIC CDA document to carry a flag to indicate when a new version of a document has only a new recipient(s) added. This will allow system to update the current held version with the new version without user involvement. The system behaviour on receipt of a document containing the flag is not defined or mandated, but the functionality of adding the flag within a document is mandated.

23.1 How the Code (flag) is carried

A code is carried within the text section code attribute and there is a text section with human readable description.

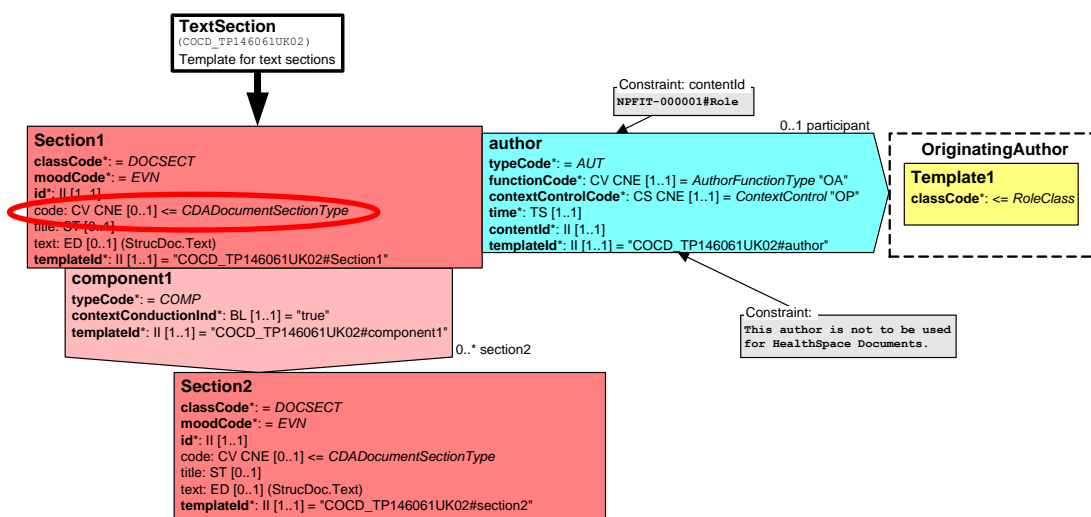

The vocabulary CDADocumentSectionType now has a sub vocabulary of DocumentChangeType which uses the OID 2.16.840.1.113883.2.1.3.2.4.17.267. This vocabulary has a code of "RLCO" which is used with this requirement.

Systems can use the presence of this code to filter documents that are the same except for a new or changed recipient list and then implement some system behavior such as not flag these documents to users.

Sending systems would still send a new version to PSIS and all previous recipients therefore meeting PSIS architecture requirements and supporting nullification.

The code in line with the rules stated in the MIM on use of text section code will only be processed by accredited HSCI systems and ignored by PSIS and all other systems.

Important note:-This code and the associated text MUST be removed for a normal update to take place. Therefore, ONLY HSCI accredited systems can update HSCI documents.

23.2 Rules for Text Format

- Text section containing the text about the recipient changes must be the first text section
- Only recipients added for current version must be contained in the text section
- All recipients are still shown at end of document as per normal rules
- The text section text must be in the following format

23.3 CDA Attributes / Artifacts Used to Meet Requirements

Requirement - The system MUST allow the user to indicate on an amended document that the only change is to the recipient list.

Attribute - Code of "RLCO" in first text section.code

Requirement - The document MUST be sent to all the previous recipients (including PSIS where appropriate).

Artifact - The recipient list in the current version must be updated and used within new version of the document.

Requirement - The amendment details MUST include:

A Text heading "document amended"

Attribute - first text section.title in the document shall contain the string "Document amended"

Amendment date

Attribute - ClinicalDocument.author.time

Version number

Attribute - ClinicalDocument.versionNumber

Author i.e. the person making the change

Artifact - AuthorSDS template

Requirement - Description of change: this will need to cater for a coded category of "change of document recipients" with human readable text detailing how the recipient list has changed. E.g. Joe Bloggs added as new OT recipient

See above for the attributes used

23.4 XML example

```
<section moodCode="EVN" classCode="DOCSECT">
  <templateId root="2.16.840.1.113883.2.1.3.2.4.18.2"
    extension="COCD_TP146061UK02#Section1"/>
  <id root="7D5E5B00-AE1A-11DB-96A5-B18E1E0994CD"/>
  <code code="RLCO" codeSystem="2.16.840.1.113883.2.1.3.2.4.17.267"/>
  <title>Document Amended</title>
  <text>
    <paragraph>
      Added Joe Bloggs as copy recipient
    </paragraph>
  </text>
</section>
```

23.5 Rendered example

NHS Number:	9413946000
Document Created:	13-Aug-2007, 14:30
Document Owner:	Hebburn NHS Trust
Authored by:	Nick Cotterell-Chapman - Physiotherapist, Hebburn Hospital on 13-Aug-2007, 14:30

Specialist Assessment Outcome	
Encounter Type:	Face to face Consultation
Encounter Time:	13-Aug-2007, 14:30
Care Setting Organisation:	Hebburn NHS Trust
Care Setting Location:	Ward 5
Care Setting Type:	Ward on NHS hospital site

Change to recipient list only

Added recipient Joe Bloggs

Assessment Outcome Summary

General Comments:

Mr Jones generally mobilising well with stick, but lacking confidence since his fall.

Assessment Outcome Summary

23.6 Illustration of process

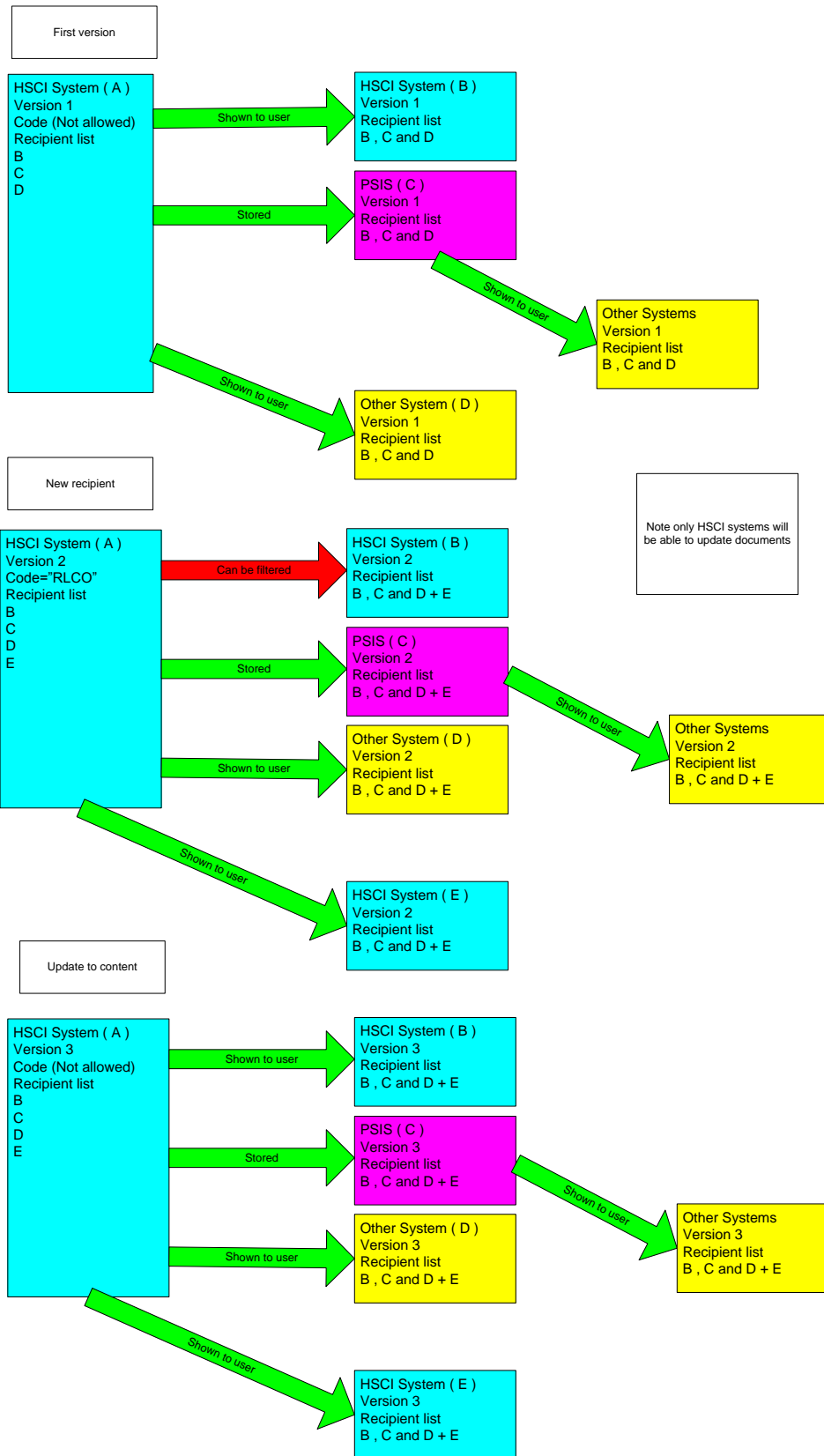

24 Discounted Options During Template Development

24.1 Actrefs and Dummy templates

Note: - option 1 method (as referred to in Use of Required Participations and Relationships section) for act refs cannot be used where a participant or relationship is used with templates without the use of dummy templates due to the fact the contentId is mandatory. Although the use of dummy templates is technically feasible, this option was discounted for the following reasons.

- Not considered good technical solution
- Requires multitude of dummy templates
- Increased message/document size

25 Universal Templates

25.1 Background

HSCIC CDA documents are a constrained version of the balloted HL7 CDA release (R2 2006). The balloted version of CDA is a generic specification which needs to be constrained in some way for any given implementation of CDA to be undertaken successfully. The constraining of the generic CDA specification for a specific implementation is what is commonly known as creating a profile of CDA.

HSCIC has created many profiles of CDA which conform to the NPfIT CDA RMIM which is the constrained model created for PSIS conformant CDA documents. Most HSCIC profiles require SDS and PDS connectivity; the universal templates were designed to remove that restriction, details of these changes are specified in the latest version of “Representing People, Places and Devices using HSCIC Templates” FileCM reference NPFIT-FNT-TO-DPM-808

Other changes to the profiles to support universalisation have also been implemented such as introduction of NonXMLBody, attachments and coded entry templates that use coding systems other than SNOMED CT. These changes are documented in this section of this document. The changes to universalise the HSCIC CDA documents required a less constrained generic model than the NPfIT CDA RMIM, so a new generic model called the NHS CDA RMIM was produced. These two models are compared and documented later in this section.

25.2 Approach to Universalisation

The intent of the universalisation approach is to create universal profiles which are not dependant on SPINE connected services and also do not need SNOMED CT to send coded information.

The universal profiles for HSCIC CDA documents have been developed using what is referred to as “universal templates”. These profiles will be referred to as “Universal profiles”. For role based templates initially the universal templates will be modified copies of the existing templates which were designed for Spine services, but with certain attributes less constrained and/or containing

information that was previously looked up from a SPINE connected service. All universal role templates have universal in the name to allow easy identification. Some pre-existing templates, which did not make use of SDS ids (so in fact were universal already), have been renamed to include the word universal for consistency.

Note: Most universal templates use 'GB' as the realm identifier within their artefact ID replacing 'UK'. This change has been implemented to all new HSCIC messaging artefacts and should not be used to identify universal artefacts.

For coded entry templates, the original coded entries have been renamed to include the text SNOMED CT with the same ID retained and the new non SNOMED templates have the name or the original template with a different ID.

An example of a renamed coded entry template and new alternative coding coded entry template.

Original Template Name	Renamed Template (SNOMED CT)	New Alternative Coding Template Name
BloodPressure	BloodPressureSNOMEDCT	BloodPressure
Original Template ID	Renamed Template (SNOMED CT) ID	New Alternative Coding Template ID
COCD_TP146013UK04	COCD_TP146013UK04	COCD_TP146313GB01

25.3 Use of Local Identifiers

The universal templates allow the use of "local identifiers". Local identifiers are only useful where the identifying system is understood by the receiving system. For this reason it is recommended that local identifiers are only used where there is a common understanding of the identifier system, for example within the same organisation or locality.

25.4 Comparison of the Two Generic Models

There are now two constrained models used to constrain the structure of HSCIC CDA instances at level one of the validation.

NPfIT CDA RMIM - POCD_MT000001UK04

This model was originally developed for the NPfIT programme to constrain the structure of HSCIC CDA documents flowing over TMS and/or stored in PSIS. Localisation has been applied to the model and to the schema to support the HSCIC templating approach. Templated models specified in each domain may further constrain CDA documents for that domain.

NHS CDA RMIM - POCD_MT000002UK01

This model has been developed to allow a more flexible approach to CDA when implemented using ITK or point to point on TMS for new post NPfIT message flows.

This model is the balloted CDA model in CDA 2006 Release 2. Localisation has been applied to the schema to support the HSCIC templating approach. Templated models specified in each domain may further constrain CDA documents for that domain.

The important differences between the two models are detailed in the table below and the classes involved.

Class	NPfIT CDA RMIM - POCD_MT000001UK04	NHS CDA RMIM - POCD_MT000002UK01
Consent	Removed	Present
NonXMLBody	Removed	Present
Section.Subject RelatedSubject SubjectPerson	Removed	Present
RegionOfInterest	Removed	Present
ObservationMedia	Removed	Present
ExternalObservation	Removed	Present
ExternalProcedure	Removed	Present

Consent Class

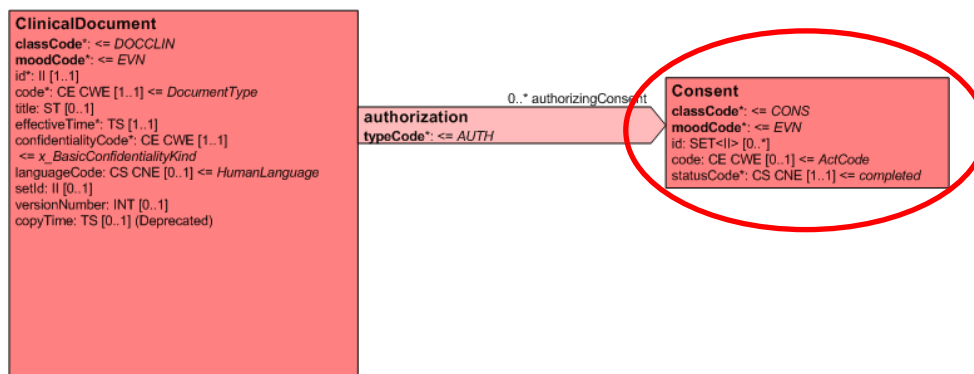

NonXMLBody Class

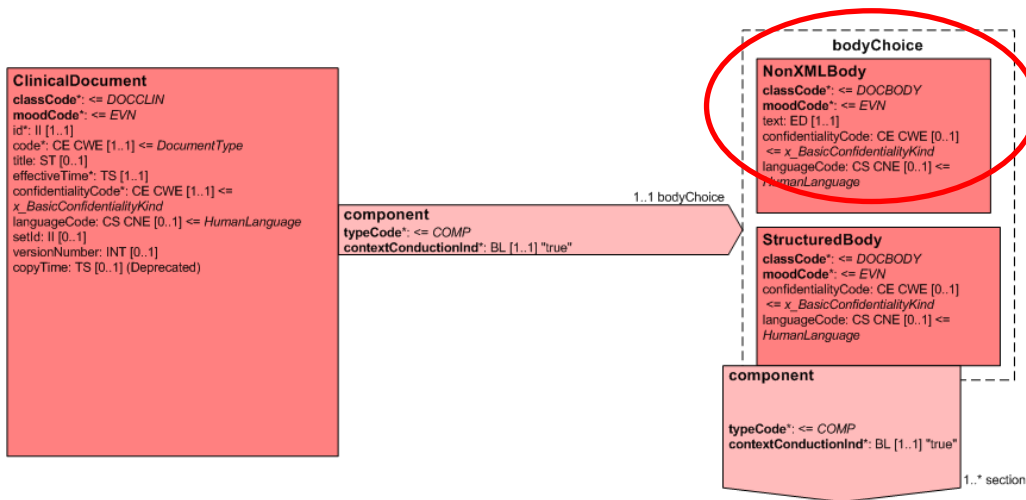

Section.Subject Class

Section.Subject Class.RelatedSubject

Section.Subject Class.RelatedSubject.SubjectPerson

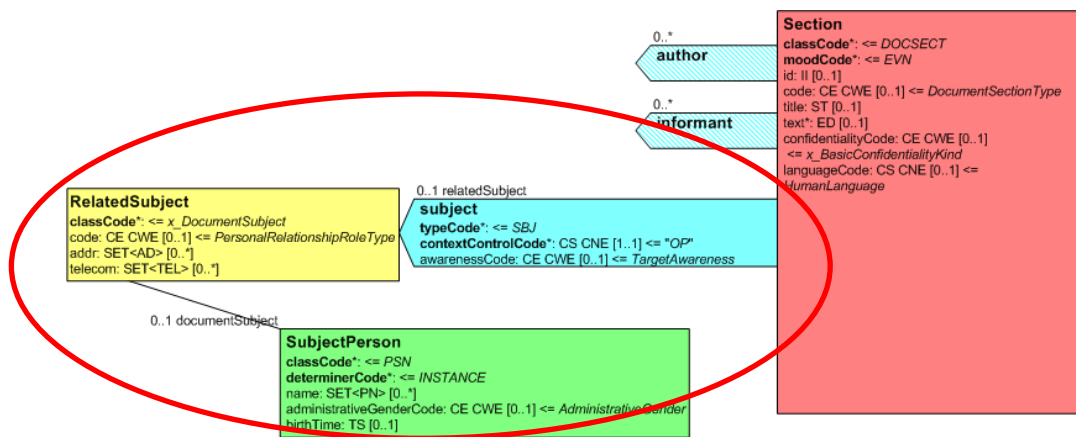

RegionOfInterest Class

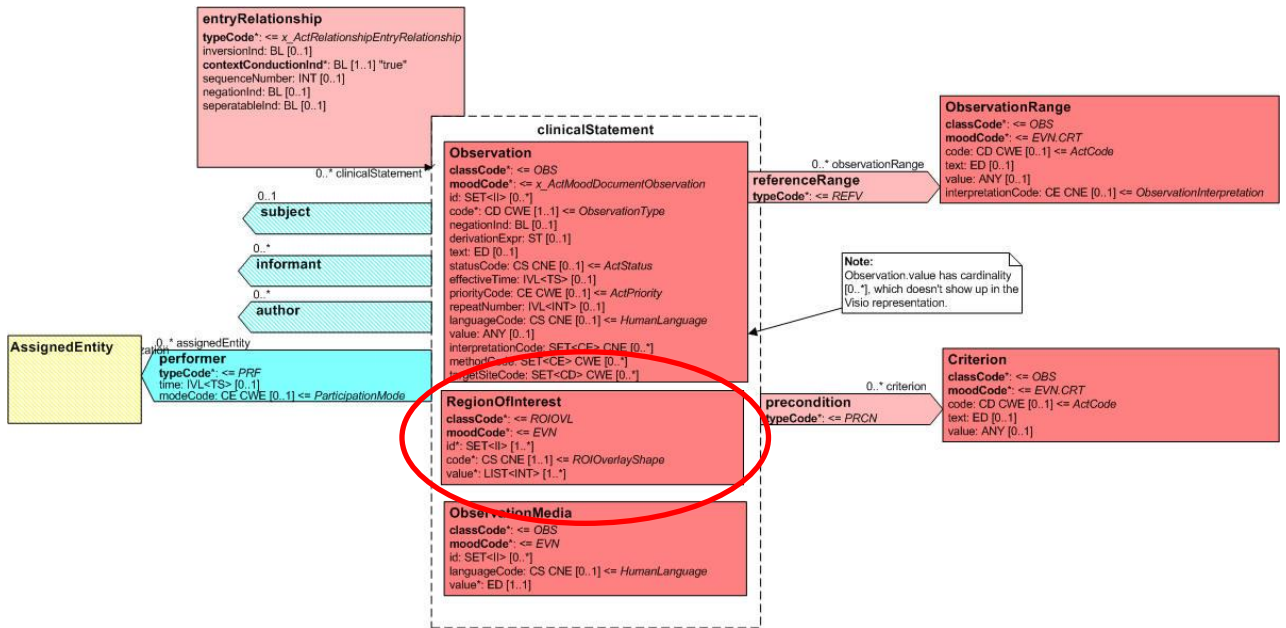

ObservationMedia Class

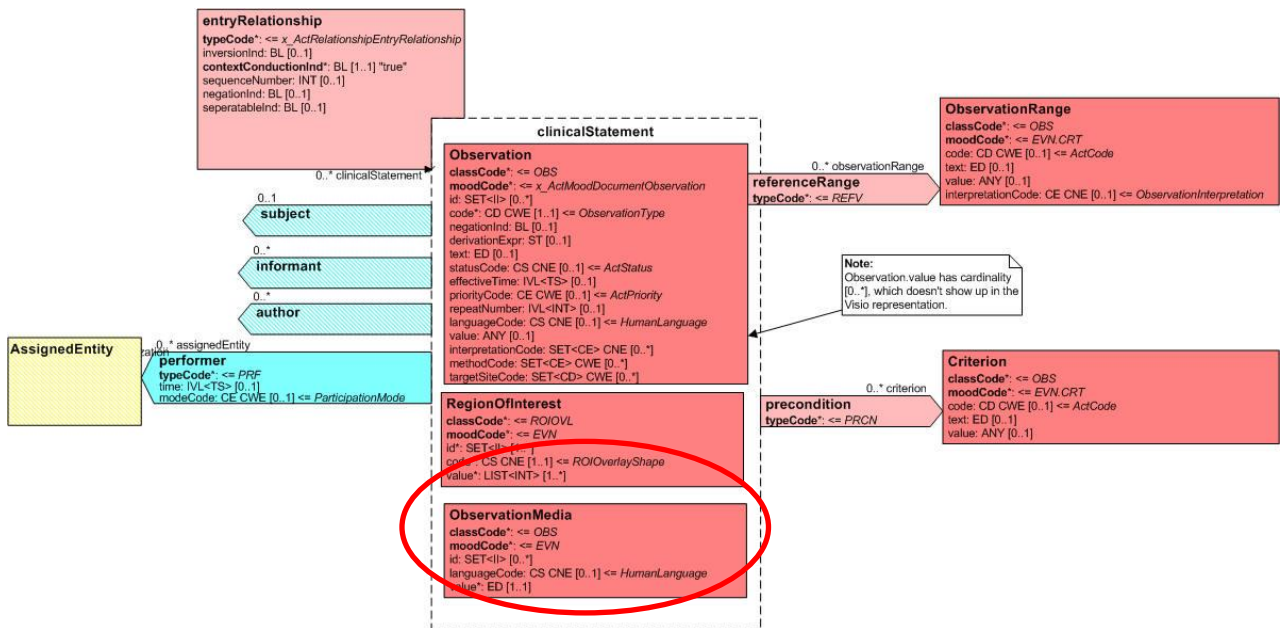

ExternalObservation Class

ExternalProcedure Class

ExternalDocument Class

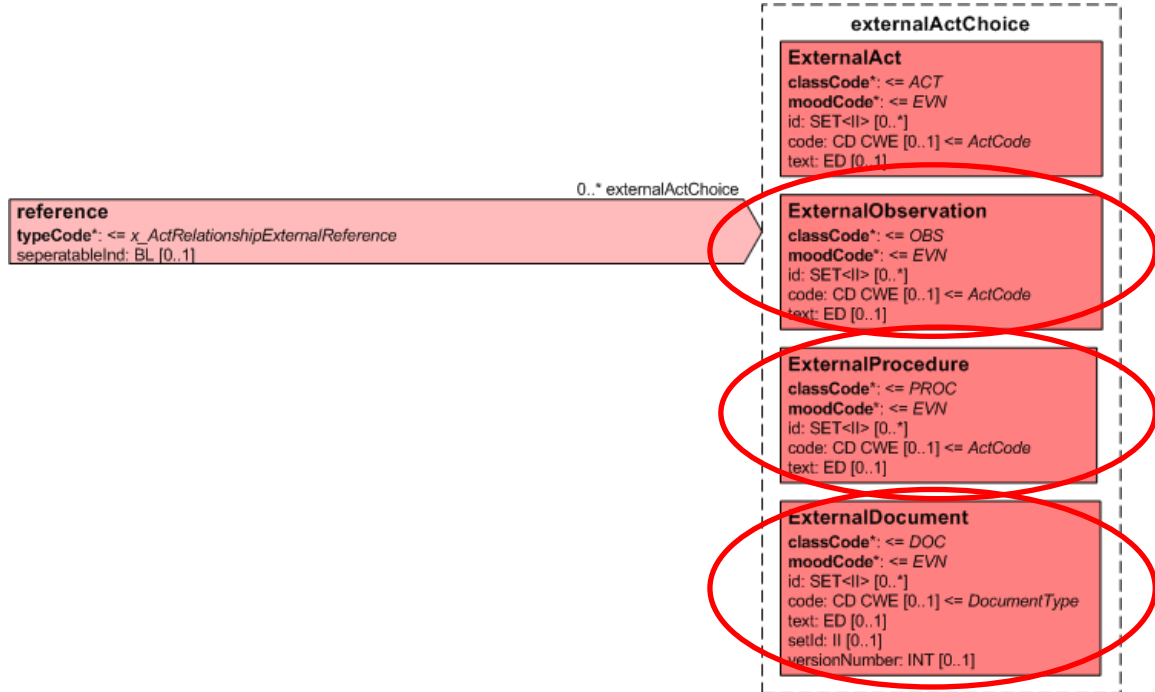

25.5 Attachment Template

This template allows attachments to be included in the CDA document. The attachment is carried in the value attribute using the ED datatype.

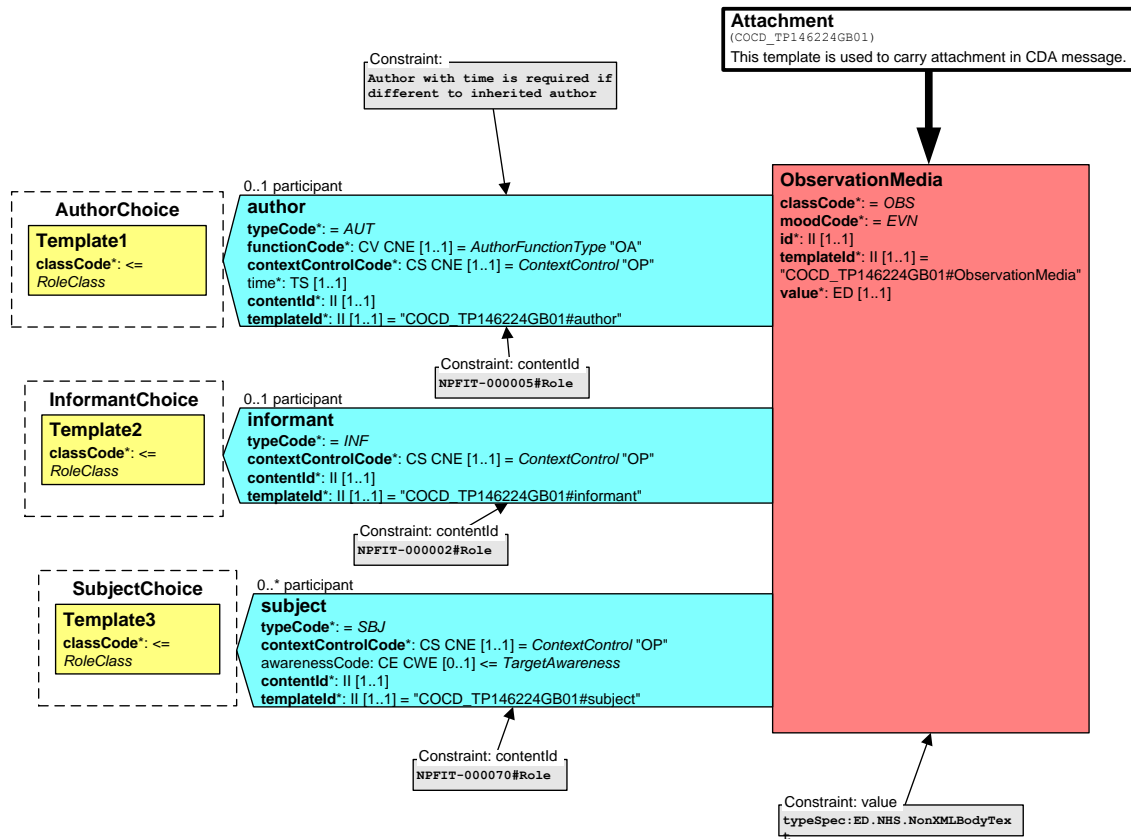

25.6 NonXMLBody

The NonXML body allows other formats of body other than the structured body.

Note that when NonXMLBody is used coded entry are not allowed.

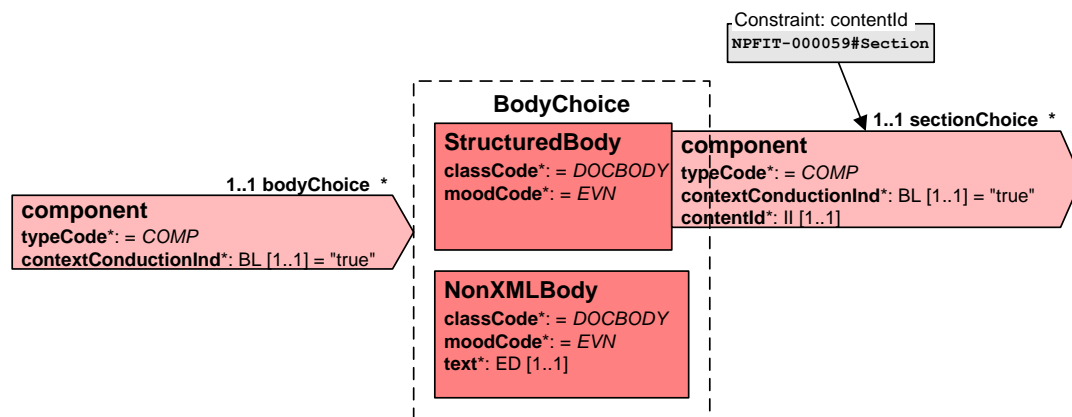

25.7 Coded Entries Using Alternative Coding to SNOMED CT

Original family history template now renamed with SNOMEDCT in the name

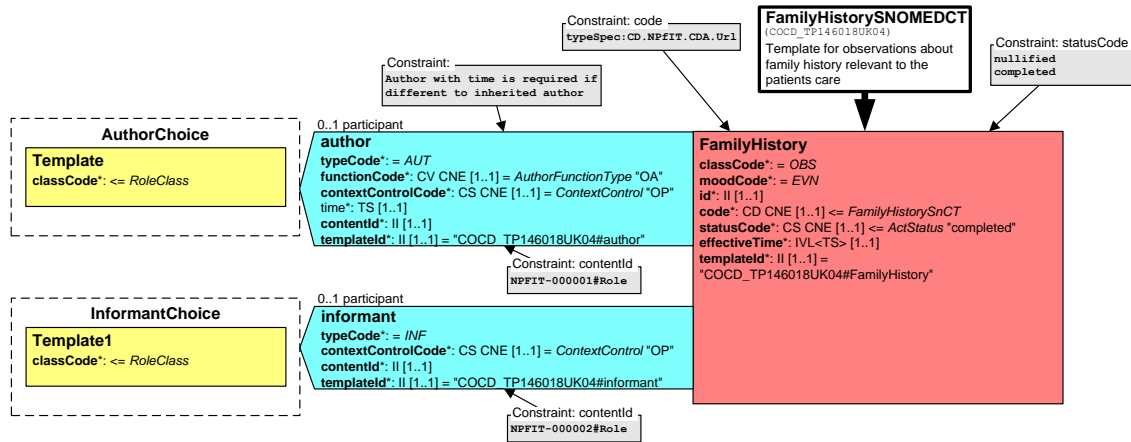

New alternative coding family history template

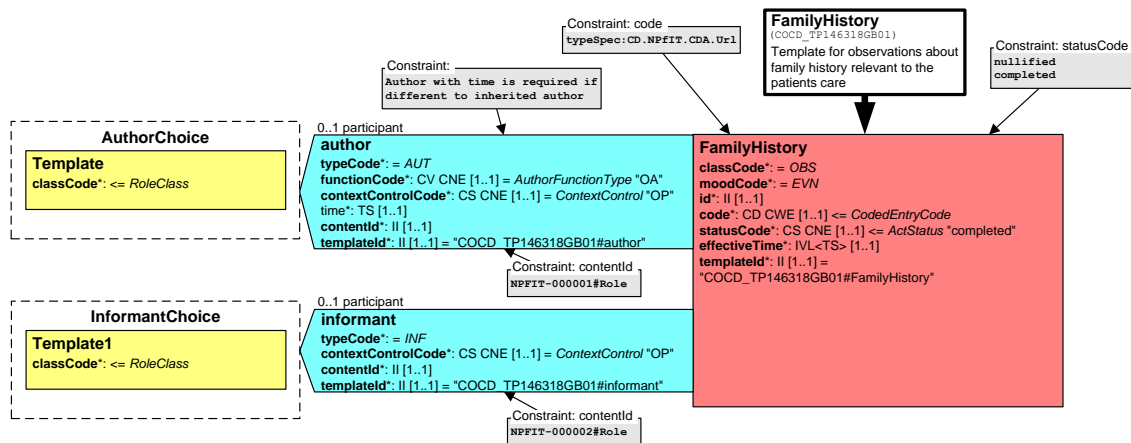

The differences to note are:-

- Code is now defined as CWE to allow alternative coding systems to be used.
- Code has a default vocabulary called CodeEntryCode, this vocabulary is only a place holder for the actual coding systems that will be used.
- The alternative coding systems that are allowed to be used will be specified at a later date
- Where there is a approved mapping from the alternative coding system to SNOMED CT then the SNOMED CT concepts must also be carried in the instance.

25.8 Universal Profiles Conformance Testing for ITK

The rules for conformance testing have been updated elsewhere in this document to reflect the changes for universalisation. When ITK interactions are tested, there are several points to note:

- The ITK interactions are abstract and therefore
 - There are no interaction schemas as ITK interactions are not bound to the wrappers in the way that TMS interactions are. Therefore, the payload and the ITK distribution envelope will need to be separated, the payload tested according to the rules stated here, and the distribution envelope tested as per the standard ITK approach.
 - The two level approach to testing should still be done using the correct “on the wire” schema for the level 1 validation

- The level 2 validation should still use the transforms and profile schemas
- The schematron should also be used to test generic and business rules.